

V-3000

Stereo Cassette Deck

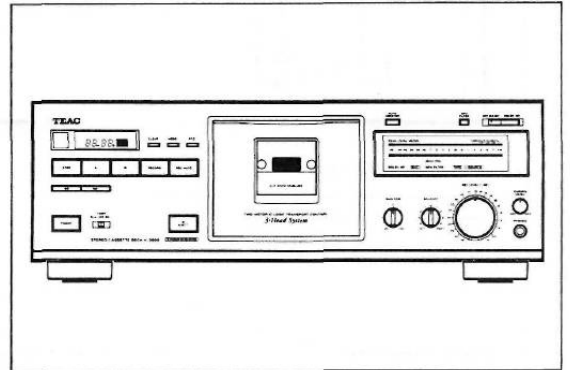

OWNER'S MANUAL

Thanks for buying a TEAC. Read this manual carefully to get the best performance from this unit.



CAUTION
RISK OF ELECTRIC SHOCK
DO NOT OPEN



CAUTION: TO REDUCE THE RISK OF ELECTRIC SHOCK, DO NOT REMOVE COVER (OR BACK). NO USER-SERVICEABLE PARTS INSIDE. REFER SERVICING TO QUALIFIED SERVICE PERSONNEL.



The lightning flash with arrowhead symbol, within an equilateral triangle, is intended to alert the user to the presence of uninsulated "dangerous voltage" within the product's enclosure that may be of sufficient magnitude to constitute a risk of electric shock to persons.



The exclamation point within an equilateral triangle is intended to alert the user to the presence of important operating and maintenance (servicing) instructions in the literature accompanying the appliance.

This appliance has a serial number located on the rear panel. Please record the model number and serial number and retain them for your records.
Model number _____
Serial number _____

WARNING: TO PREVENT FIRE OR SHOCK HAZARD, DO NOT EXPOSE THIS APPLIANCE TO RAIN OR MOISTURE.

SAFETY INSTRUCTIONS

CAUTION:

- Read all of these instructions.
- Save these instructions for later use.
- Follow all warnings and instructions marked on the audio equipment.

1. **Read Instructions**—All the safety and operating instructions should be read before the appliance is operated.
 2. **Retain Instructions** — The safety and operating instructions should be retained for future reference.
 3. **Heed Warnings** — All warnings on the appliance and in the operating instructions should be adhered to.
 4. **Follow Instructions** — All operating and use instructions should be followed.
 5. **Water and Moisture** — The appliance should not be used near water - for example, near a bathtub, washbowl, kitchen sink, laundry tub, in a wet basement, or near a swimming pool, etc.
 6. **Carts and Stands** — The appliance should be used only with a cart or stand that is recommended by the manufacturer.
- 6A. An appliance and cart combination should be moved with care. Quick stops, excessive force, and uneven surfaces may cause the appliance and cart combination to overturn.



Wall or Ceiling Mounting — The appliance should be mounted to a wall or ceiling only as recommended by the manufacturer.

8. **Ventilation** - The appliance should be situated so that its location or position does not interfere with its proper ventilation. For example, the appliance should not be situated on a bed, sofa, rug, or similar surface that may block the ventilation openings; or, placed in a built-in installation, such as a bookcase or cabinet that may impede the flow of air through the ventilation openings.
9. **Heat** — The appliance should be situated away from heat sources such as radiators, heat registers, stoves, or other appliances (including amplifiers) that produce heat.
10. **Power Sources** — The appliance should be connected to a power supply only of the type described in the operating instructions or as marked on the appliance.
11. **Grounding or Polarization** — The precautions that should be taken so that the grounding or polarization means of an appliance is not defeated.
12. **Power-Cord Protection** — Power-supply cords should be routed so that they are not likely to be walked on or pinched by items placed upon or against them, paying particular attention to cords at plugs, convenience receptacles, and the point where they exit from the appliance.

13. **Cleaning** — The appliance should be cleaned only as recommended by the manufacturer.
14. **Power Lines** — An outdoor antenna should be located away from power lines.
15. **Outdoor Antenna Grounding** — If an outside antenna is connected to the receiver, be sure the antenna system is grounded so as to provide some protection against voltage surges and built up static charges. Section 810 of the National Electrical Code, ANSI/NFPA No. 70 - 1984, provides information with respect to proper grounding of the mast and supporting structure, grounding of the lead-in wire to an antenna discharge unit, size of grounding conductors, location of antenna-discharge unit, connection to grounding electrodes, and requirements for the grounding electrode. See Figure below.

EXAMPLE OF ANTENNA GROUNDING AS PER NATIONAL ELECTRICAL CODE

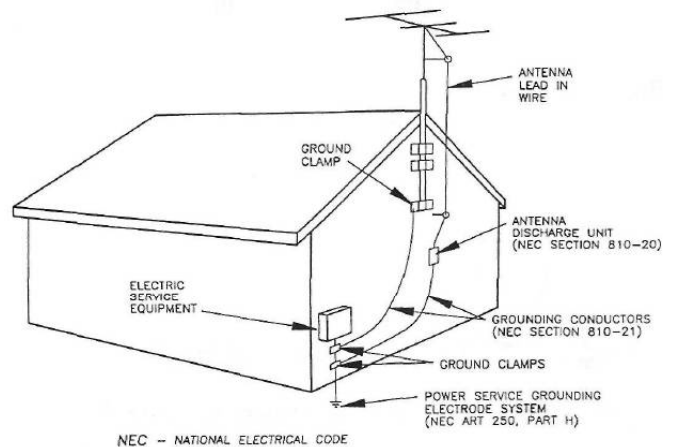

16. **Nonuse Periods** — The power cord of the appliance should be unplugged from the outlet when left unused for a long period of time.
17. **Object and Liquid Entry** - Care should be taken so that objects do not fall and liquids are not spilled into the enclosure through openings.
18. **Damage Requiring Service** - The appliance should be serviced by qualified service personnel when:
 - A. The power-supply cord or the plug has been damaged; or
 - B. Objects have fallen, or liquid has been spilled into the appliance; or
 - C. The appliance has been exposed to rain; or
 - D. The appliance does not appear to operate normally or exhibits a marked change in performance; or
 - E. The appliance has been dropped, or the enclosure damaged.
19. **Servicing** — The user should not attempt to service the appliance beyond that described in the operating instructions. All other servicing should be referred to qualified service personnel.

Reference Illustrations

Fig. 1 Front Panel

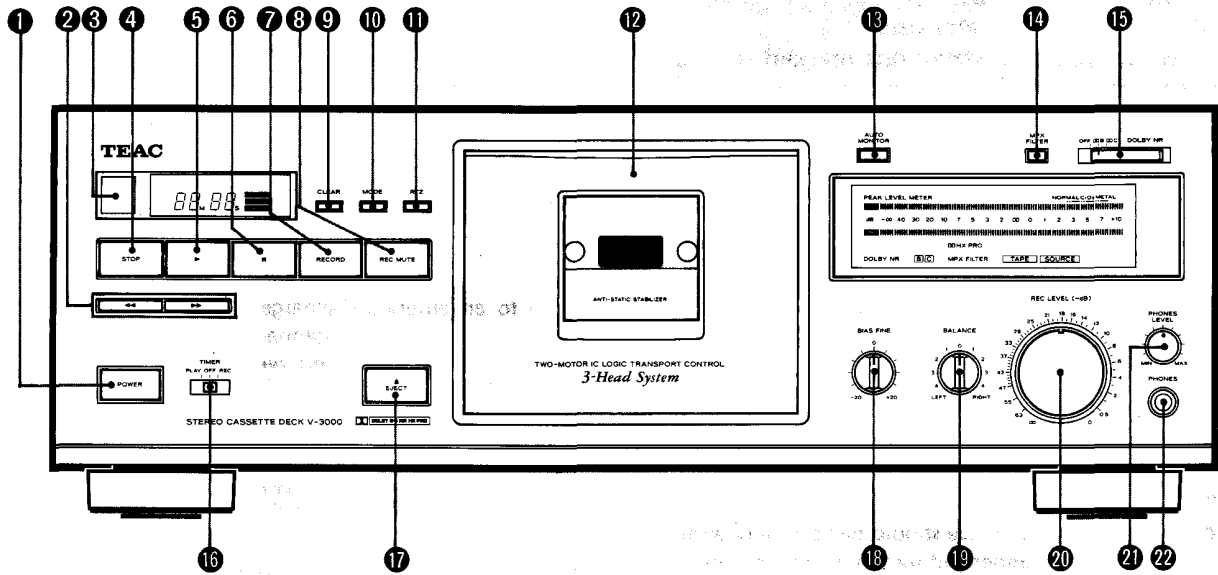

Display Window

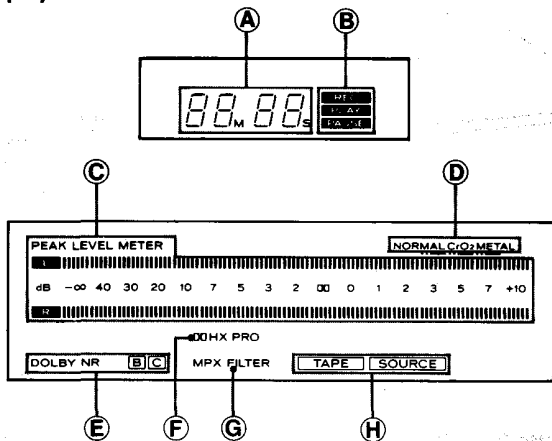

Rear Panel

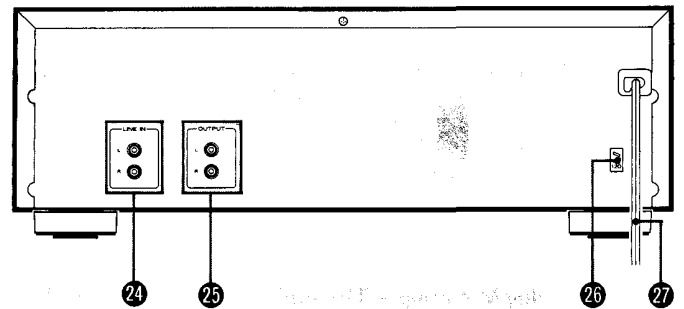

Remote Control Unit

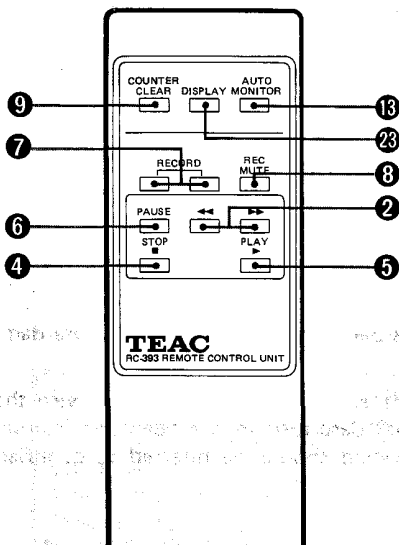

Fig. 2

Battery Placement

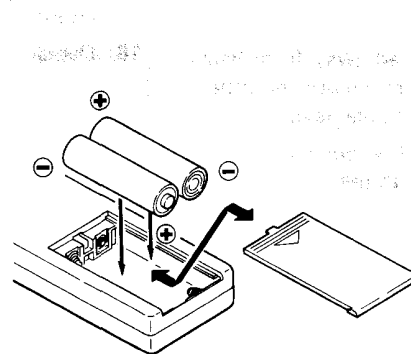

Fig. 3

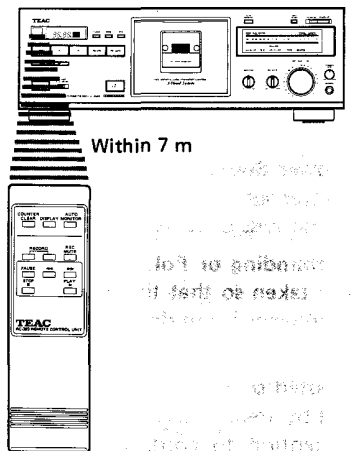

Fig. 4

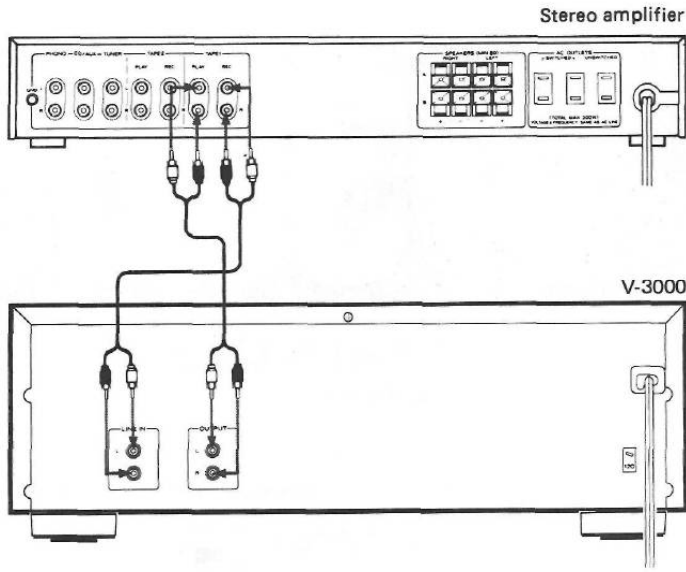

Fig. 5

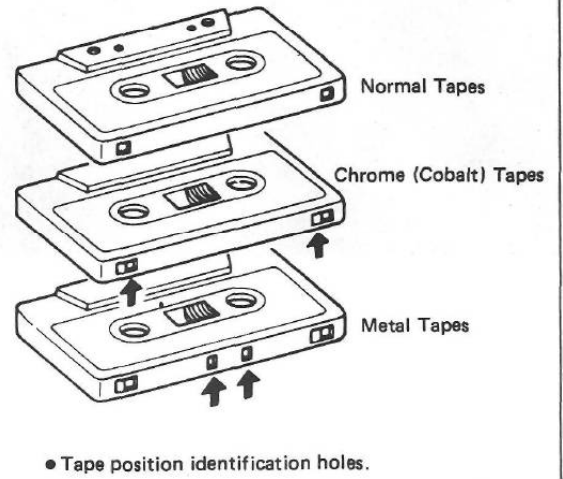

Fig. 6

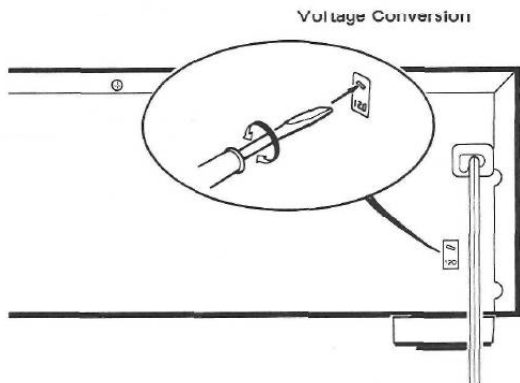

Fig. 7

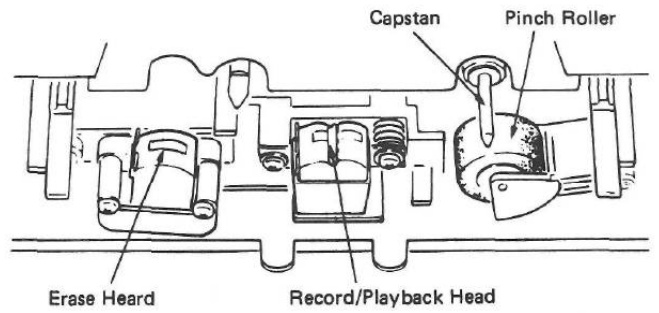
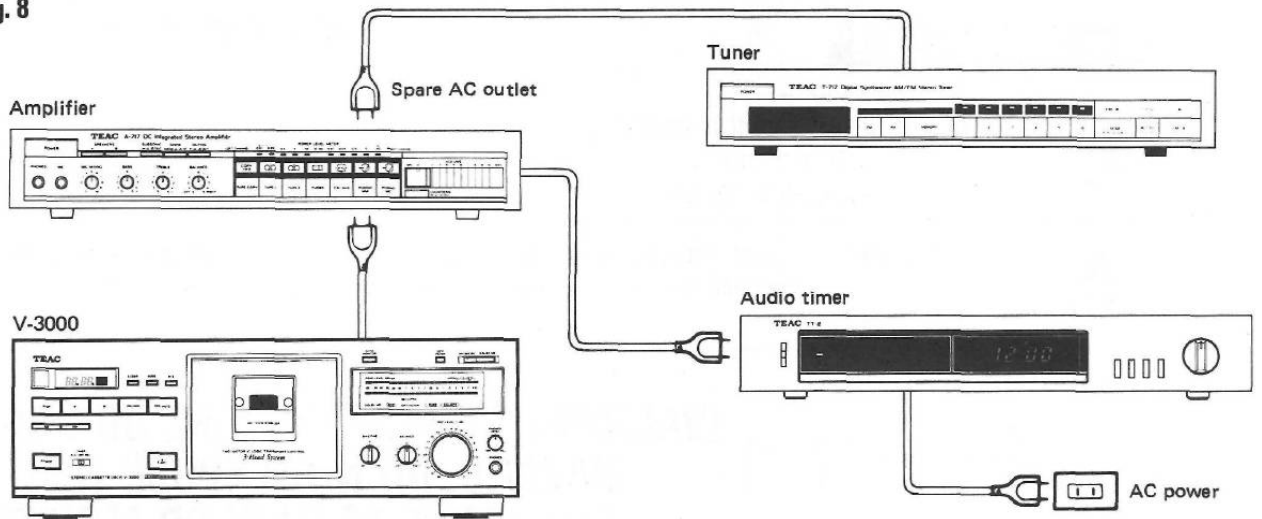

Fig. 8



Precautions

Environment

Avoid using the deck in the following circumstances:

- High temperature (such as heater, direct sunlight).
- Extremely low temperature.
- Excessive humidity.
- Dusty atmosphere.
- Where power line voltage fluctuation is severe (the use of a voltage regulator may be advisable).
- Be aware also that placing other units or any objects on the deck can leave marks depending on their weight.

Cassette Tape (Fig. 5)

Tape Selection:

For the automatic tape select function to work properly, metal and chrome (cobalt) formula tapes must have tape identification holes.

C-120 cassette tapes:

120-minute tapes are very thin, they tend to stretch and their magnetic layer is thin; they also tend to introduce wow & flutter. For these reasons, special attention is required when using them. If the pinch roller or capstan is dirty, tape might become wrapped around it and this could cause serious trouble. For this reason, it is recommended that you do not use C-120 tapes.

Tape Handling:

Do not store tape in the following places:

- On top of heaters, in direct sunlight or in any other high-temperature areas.
 - Near speakers, on TV sets or amplifiers or near any strong magnetic fields.
 - High-humidity areas or dirty, dusty areas.
- Avoid dropping or subjecting the cassettes to excessive shock.

Voltage Conversion (For general export models) (Fig. 6)

If it is necessary to change the voltage requirements of the deck to match your area, use the following procedure:

1. DISCONNECT POWER LINE CORD.
2. Using a screwdriver, turn the selector until the desired voltage marking appears.

f ;J, i

IMPORTANT (for U.K. Customers)

The wires in this mains lead are coloured in accordance with the following code:

BLUE: NEUTRAL
BROWN: LIVE

As the colours of the wires in the mains lead of this apparatus may not correspond with the coloured markings identifying the terminals in your plug, proceed as follows:

The wire which is coloured BLUE must be connected to the terminal which is marked with the letter N or coloured BLACK. The wire which is coloured BROWN must be connected to the terminal which is marked with the letter L or coloured RED.

In the U.K. this unit is sold without an AC plug.

THE APPLIANCE CONFORMS WITH EEC DIRECTIVE 87/308/EEC REGARDING INTERFERENCE SUPPRESSION

^ Dolby noise reduction and HX Pro headroom extension manufactured under license from Dolby Laboratories Licensing Corporation. HX Pro originated by Bang & Olufsen. "DOLBY", the double-D symbol DO and "HX PRO" are trademarks of Dolby Laboratories Licensing Corporation.

Connections (Fig. 4)

- Turn off power for all equipment before making connections.
- Read instructions for each component you intend to use with the deck.

Features and Controls (Fig. i)

Front Panel/Remote Control Unit

POWER Switch

Press to switch the deck on. The display window will be illuminated. Press again to turn the deck off.

Note: Be sure to wait more than 2 seconds after the power has been switched off before switching the power on again.

0 ** (Rewind) Button/ •• (Fast-Forward) Button

When these buttons are pressed, the tape is rewound or fast-forwarded.

© REMOTE SENSOR (Remote Control Infrared Signal Receptor)

This receives signals from the provided RC-393 infrared remote control unit.

OSTOP Button

Press to stop the tape travel and release any other mode.

© • (Play) Button

Pressing this button starts normal-speed playback.

0 II (Pause) Button

Press to temporarily stop tape travel during recording or playback. In the pause mode, the PAUSE indicator in the display lights. Press the • button or II button again to restart the tape (the indicator goes out).

ORECORD Button

Press the RECORD button to set the deck to the record-pause mode. The REC and PAUSE indicators will light. To start recording, press the • button or II button. To enter the record mode using the remote control, press the two RECORD buttons simultaneously.

© REC MUTE Button

Press this button during recording to leave a blank section between tunes (approx. 4 seconds). The deck will enter the record-pause mode. Press the • button or II button to start recording again. (See page 7.)

© CLEAR Button

Pressing the CLEAR button resets the multi-counter to "0000".

© MODE Button

When this button is pressed, the display alternates between the conventional tape counter and the TRT (tape-run-time) counter.

< DRTZ (Return to Zero) Button

If this button is pressed, the tape is fast-forwarded or rewound until a tape counter reading of "0000" is reached, then the deck stops. (See page 8.)

<D> Cassette Holder

Load the cassette here.

<D A U T O MONITOR Button

This button allows you to select which signal is to be monitored with its level displayed on the meter. When power is applied to the deck, the monitor mode is set to TAPE, showing that the signal recorded on the tape is monitored with its level displayed by the meter. When the deck enters the record-pause mode, the monitor mode is automatically switched to SOURCE, showing the signal input to the deck (from the LINE IN jacks on the rear panel) is monitored with its level displayed. And when the record-pause mode is released, it is automatically changed to TAPE. To manually change the monitor mode, press this button.

<E>MPX FILTER Switch

Press this switch when making a Dolby NR recording of an FM broadcast; the indicator lights. It eliminates the pilot tone (19 kHz) and sub carrier tone (38 kHz) of the FM broadcast which could affect operation of the Dolby noise reduction system. To release this function, press the MPX FILTER switch again.

Ⓞ DOLBY NR Switch

OFF; Set to this position when you do not want to use any noise reduction system.

•• B: Set to this position when making a recording using the Dolby B noise reduction system, or playing back tapes recorded with Dolby B NR.

•• C: Set to this position when making a recording using the Dolby C noise reduction system, or playing back tapes recorded with Dolby CNR.

Ⓞ TIMER Switch

PLAY: For timer playback

OFF: Set to this position when not using a timer.

REG: For timer recording

(See page 8.)

Ⓞ EJECT Button

Press in the stop mode to open the cassette holder. Do not press this button when the deck is in the recording or playback mode.

(D BIAS FINE Tuning Contrd

This control allows fine bias level setting when recording. The center "click" position provides a standard amount of bias current depending on the type of tape.

Turning the control toward "+" increases the amount of bias and thus decreases high frequency response.

Turning the control toward "-" decreases the amount of bias and thus increases high frequency response.

Keep this control in the center position when the function is not being used.

Ⓞ BALANCE Control

Adjust the balance of the left and right channels of the input signals to be recorded on tape.

Ⓞ REC LEVEL Control

When recording, turn the REC LEVEL control clockwise to fade the input sound in or turn it counterclockwise to fade the sound out, for smooth tune-to-tune transitions.

^ PHONES LEVEL Control

Adjust the level of the signals output from the PHONES jack. This knob does not affect the level of the signals output from the OUTPUT jacks on the rear panel or the level indicated by the PEAK LEVEL METER.

Ⓞ PHONES Jack

Connect 8 ohms stereo headphones to this jack for private listening or monitoring.

Ⓞ DISPLAY Button

Press this button to switch off the display. Press it again to switch it on.

Display JVin^pj^,,

Ⓞ Multi-Counter Tape Counter Mode

In this mode, the counter functions as a conventional tape counter, counting up when the tape is moving forward and down when the tape is being rewound. The display can be cleared by pressing the CLEAR button, which resets the counter index to "0000".



TRT (Tape-RunTime) Counter Mode

In this mode, tape travel is measured in minutes and seconds up to a maximum of 99M59S (99 minutes 59 seconds). Since this counter only functions in the play and record modes, it will be interrupted when the tape is fast-forwarded or rewound (and, of course, in the stop mode); counting up will be resumed when playback or recording restarts. The display can be cleared by pressing the CLEAR button which resets the counter index to "OOMOOS".

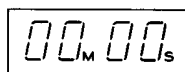

Ⓞ Transport Mode Indicators

REC: Lights when the deck is in the record and record-standby modes, and flashes during record-muting.

PLAY: Lights when the deck is in the playback and record modes.

PAUSE: Lights when the deck is standing by for playback or recording.

Ⓞ PEAK LEVEL METER

This meter shows the peak level of the input or playback signal. In the record mode, the meter indicates the level of the source signals which have been adjusted with the REC LEVEL and BALANCE controls. During playback, the meter indicates the level of signals recorded on the tape.

Ⓞ Tape Type Indicator

The deck automatically detects the type of tape which has been loaded, and these indicators (NORMAL, CrO, and METAL) indicate the type of tape being used.

Ⓞ DOLBY NR E E Indicator

Lights when the DOLBY NR switch is set to the •• B or DD C position.

Ⓞ DD HX PRO Indicator

Lights when the deck enters the record mode, showing that the built-in Dolby HX Pro circuit has been activated. For details, refer to page 9.

Ⓞ MPX FILTER Indicator

Lights when the MPX FILTER switch is pressed in (n).

Ⓞ Auto Monitor Indicators

TAPE: Lights when the tape signal is selected either in playback or record.

SOURCE: Lights when the source signal is selected.

The Auto Monitor indicator changes automatically to the monitor mode so that the SOURCE indicator lights when the deck enters the record-pause mode. When recording starts, the SOURCE indicator automatically goes out and the TAPE indicator lights.

• ? » Panel'

Ⓞ LINE IN Terminals

Connect the amplifier's REC OUT jacks to these jacks.

Ⓞ OUTPUT Terminals

Connect the amplifier's TAPE PLAY or LINE IN jacks to these jacks.

Ⓞ Voltage Selector (General export models only)

See "Voltage Conversion" on page 5.

Ⓞ Power Supply Cord

Insert into an AC wall outlet, etc. The voltage required by this unit is shown on the rear panel.

Operations

Playback and Recording

Stereo Playback

1. Set the TIMER switch to OFF.
2. Press the POWER switch to ON.
3. Load a pre-recorded cassette.
4. Select the NR system with the DOLBY NR switch.
5. Press the **•** button to start playback.
6. Adjust the volume with the amplifier's control.

Stereo Recording

1. Set the TIMER switch to OFF.
2. Press the POWER switch to ON.
3. Load a recordable cassette.
4. Select the required NR system with the DOLBY NR switch.
5. Press the MPX FILTER switch to IN when making a Dolby NR recording of an FM broadcast.
6. Press the RECORD button (both the REC and PAUSE indicators light). This enables you to adjust the recording level without actually recording on the tape.
7. Adjust the REC LEVEL and BALANCE controls so that the loudest peak briefly reaches the meter reference reading for the type of tape used for both channels.
8. Adjust the BIAS FINE tuning control described in "Using the BIAS FINE Tuning Control".

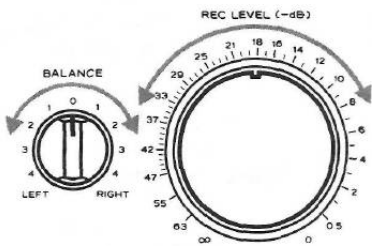

9. Press the **•** button or **ii** button to start recording. The REC and PLAY indicators light.

The Auto Monitor indicator is automatically changed to TAPE and the signal can be directly monitored immediately after it is recorded. To compare the recorded sound with the original source, press the AUTO MONITOR button to switch the signal being monitored between TAPE and SOURCE.

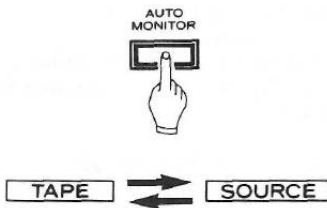

Notes:

- To stop recording, press the STOP button.
- To momentarily stop recording, press the **||** button. To resume recording, press the **••** button or **ii** button.

Note:

Recording prerecorded tapes, records, or other published or broadcast material may infringe copyright laws. Check these laws before recording.

Setting the Recording Level

Setting the recording level correctly is essential if you want to make top-quality recordings. If the level is too low, the recording will be noisy. If the level is set too high, the recording will be distorted. Generally speaking, the recording level should be set so that the loudest peak to be recorded makes the meters briefly indicate the meter reference reading for the type of tape used. If the meters peak over the reference reading, decrease the recording level by turning the REC LEVEL control counterclockwise. However, some program material or different tape formulations may require higher or lower recording levels. With a little time and practice you will be able to select the critical recording level that gives you the best hi-fi recordings. The optimum setting of the recording level will differ according to the type and condition of the tape, as well as the type of music you are recording.

Using the BIAS FINE Tuning Control

The center position provides the standard amount of bias current. Turning the control toward "+" increases the amount of bias current; a slight decrease in high-frequency response will be obtained. Turning it toward "-" decreases the amount of bias current; a noticeable increase in high-frequency response will be obtained.

1. Set the deck in the record mode and begin recording by using a disc or a prerecorded tape the sound quality of which you are familiar with.
2. Set the AUTO MONITOR button to TAPE to monitor the reproduced sound. If the high frequency sound seems greater than the original, turn the BIAS FINE tuning control toward "+" to obtain the best possible sound. On the other hand, if the high frequency sound seems low, turn the control toward "-" until the appropriate bias current is obtained.

3. As a final check, alternately set the AUTO MONITOR to SOURCE or TAPE to confirm the correct setting of the BIAS FINE tuning control by comparing the recorded sound with the original.

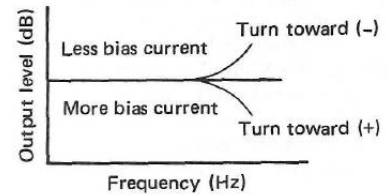
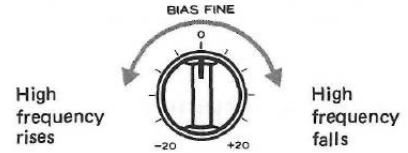

Erasing

A previously recorded tape will be automatically erased when you make a new recording on it. Alternatively it can be erased by "recording" on it with the REC LEVEL control set to "00".

Record Muting Operation

The ability to leave blank unrecorded (erased) portions on a tape during recording is a real advantage in many recording situations. For instance, you may want to eliminate undesired portions of an FM broadcast that you are recording, such as commercials, station breaks or announcements. You may want to record a complete program with controlled spacing between each song. Such blank portions on a tape can be easily left using the REC MUTE function.

1. Automatic Spacing operation - for a 4-second blank - (during recording or record-pause mode)

Press the REC MUTE button during the recording or record-pause mode. The tape continues to run, and a blank space of about 4 seconds is recorded (the REC indicator flashes). The deck then switches automatically to the record-pause mode (both the REC and PAUSE indicators light). To start recording the next tune, press the **•** button or **ii** button (both the REC and PLAY indicators light).
2. For a Blank of More Than 4 Seconds
3. During recording, keep the REC MUTE button pressed for a longer blank period. Release the button to enter the record-pause mode. To begin recording, press the **•** button or **ii** button.

- For a Blank of Less Than 4 Seconds
After pressing the REC MUTE button during recording, press the **n** button, before the 4-second interval has elapsed, to cancel the muting mode and engage the record-pause Mode. To begin recording, press the **•** button or **ii** button.

Multi-Counter Function

With the multi-counter facilities incorporated in the unit, there are two different display modes available, depending on the setting of the MODE button.

Tape Counter Mode: The counter functions as a conventional taps counter.

TRT Counter mode: The counter functions as a tape-run-time counter, measuring tape travel in minutes and seconds.

Using as a Tape Counter

Using the MODE button, call up the tape counter mode; a 4-digit display will appear. Its function is identical to that of a conventional tape indexing counter. During recording (including record muting), playback and fast-forward, the counter counts up as the tape moves from left to right, and down during rewind as the tape moves from right to left. The indicated numerals are not related to elapsed time and are not compatible with the counter readings of other cassette decks. One typical example of using this display in the conventional tape counter mode is: First load a cassette and before recording, press the CLEAR button to reset the counter to "0000". Then note the counter reading at the beginning of each piece of music to facilitate locating that particular selection when you wish to play it back.

Using as a TRT Counter

Using the MODE button, call up the tape-run-time mode; "M" appears between the 2nd and 3rd digits and "S" at the end of the 4th digit. In this mode, tape travel is measured in minutes and seconds while the tape is running at normal speed during recording (including record muting) and playback. Counting stops during rewind and fast-forward. This function can be used to measure the approximate length of a recorded song or to make an estimate of how much tape is left.

"Visible" and "Invisible" Counters

Both counter modes are switchable at any time, with the one selected appearing on the display and the other functioning in memory. For example, when the conventional tape counter is selected with the MODE button, counting of the tape-run-time also takes place and its reading can be called up at any time by pressing the MODE button. Pressing the CLEAR button resets only the counter which is currently displayed. Both counters, "visible" and "invisible" are reset when power is switched off.

RTZ (Return To Zero) Function

To locate the position on the tape corresponding to a tape counter reading of "0000", press the RTZ button.

The fast-forward or rewind of the tape starts. When a counter reading of "0000" is detected, the deck stops.

This function is handy to locate the beginning of tune to be played back.

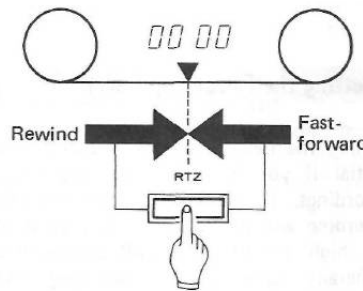

To start playback from "0000":

While the tape is running after the RTZ button is pressed, press the **•** button. The deck temporarily stops at the "0000" counter reading, then playback starts.

To release the RTZ function:

Press the STOP button. If the **->** (rewind) or **<->** (fast-forward) button is pressed while the tape is running after the RTZ button is pressed, the RTZ function is released, and the deck enters the normal rewind or fast-forward mode.

*The RTZ button cannot be used when the deck is in the recording mode or near the "0000" counter reading.

Timer-Controlled Operations(Fig.8)

Timer-Controlled Recording

- Connect your deck and stereo system to a commercially available audio timer as shown in the diagram.
- Make all the preparations as for normal recording, but leave the deck in the stop mode.
- Set the audio timer to the required start (power on) and stop (power off) times.
- Set the TIMER switch on the deck to REC.

When the preset start time is reached, power will be supplied and recording will start.

Timer-Controlled Playback

- Check that the deck is correctly connected to the amplifier for normal playback operation.
- Connect the deck and amplifier to an audio timer as for timer-controlled recording (above).

- Make all preparation as for normal playback, but leave the deck in the stop mode.
- Set the audio timer to the required start (power on) and stop (power off) times.
- Set the TIMER switch on the deck to PLAY.

When the preset start time is reached, power will be switched on and playback will start.

Note: Be sure to set the TIMER switch to OFF after timer-controlled recording or playback is over.

Remote Controlled Operation ** *

The provided RC-393 remote control unit allows the V-3000 to be operated from a distance. The control buttons on the remote control unit function in almost the same way as those on the front panel of the V-3000, but they have slightly different names, etc.

Precautions on Remote Control Operation

1. Battery Replacement (Fig.2)

- Remove the lid.
- Insert 2 "AA" type dry batteries. Be sure that the batteries are inserted with their negative and positive terminals positioned correctly.
- Close the lid until it clicks.

How often should the batteries be changed? The batteries will normally last about six months. However if you notice that the distance between the remote control unit and the V-3000 required for operation becomes shorter, the batteries should be changed. Replace the batteries with two new ones.

Precautions Regarding Batteries

- Be sure to insert the batteries with the positive (+) and negative (-) terminals positioned correctly.
- Never use old and new batteries together.
- Replacement batteries should be of the same type. Never use batteries of different types together.
- Rechargeable and non-rechargeable batteries can be used. Refer to their precaution labels.
- Remove the batteries from the remote control unit when it will not be used for a long period of time.
- When the batteries are weak, replace them as soon as possible.
- Do not heat or disassemble batteries and do not dispose of them by throwing them into a fire.

2. Remote Control Unit RC-393

When operating using the remote control, point the front of the unit at the remote sensor of the V-3000. The remote control unit can be used within the range shown in Fig. 3.

Troubleshooting

Notes:

- Even if the remote control unit is operated within the effective range, remote control operation may be impossible if there is any obstruction between the V-3000 and the remote control unit.
- If the deck is operated in the vicinity of other appliances generating infrared rays, or if other remote control devices using infrared rays are used near the V-3000, the deck may operate incorrectly. Conversely, if the V-3000's remote control unit is operated in the vicinity of other appliances which use an infrared remote control device, the other appliance may operate incorrectly.
- When the unit will not be used for a long period of time (more than one month), remove the batteries to prevent them from leaking. If they do leak, wipe off the liquid inside the battery compartment and replace the batteries with new ones.
- Do not place books or other objects on the remote control unit as they could press the buttons and discharge the batteries.

Maintenance (Fig. 7)

The heads and tape path should be cleaned and demagnetized periodically.

Cleaning Tape Path

- Apply head cleaning fluid* to special cotton swabs or a soft cloth, and lightly rub the heads, capstans and all metal parts in the tape path.
- Also clean the pinch rollers using rubber cleaning fluid*.

*Both are available in TEAC HC-1 and RC-1 in the U.S.A. or TEAC TZ-261 Tape Recorder Cleaning Kit in other areas.

Demagnetizing Heads

Be sure that the power is off, then demagnetize the heads using a TEAC E-3 demagnetizer or equivalent. For details of its use, read its instructions.

Basic troubleshooting of a cassette tape deck is similar to troubleshooting any other electrical or electronic equipment. Always check the most obvious possible causes first. To give you a few ideas of what to look for, check the following:

- No power: Is the power cord connected?
- Tape begins running when power is turned on: Is the TIMER function on?

DOLBY HX PRO

Dolby HX Pro is an "active bias" technique that can improve the quality of audio tape recordings. High-level high frequencies can be recorded more accurately, without sacrificing signal-to-noise ratio, while such side effects of tape saturation as distortion are reduced.

What Is Bias?

Bias is a very high-frequency signal generated within a tape deck and recorded on the tape simultaneously with the program material. This inaudible signal allows a low noise, low distortion recording and flat frequency response. Different magnetic tape formulations require different amounts of bias for optimum performance. If the bias level is too high, high-frequency Maximum Output Level (MOL) decreases.

The Problem of Self-Bias

Unfortunately, bias level is often influenced by the signal being recorded. The high frequencies contained in some music act as bias. This unpredictable source of bias is added to the existing bias, resulting in a loss of high-frequency response. As the high-frequency content of the signal increases.

>No audio output. Are all connections properly made?

- Degraded sound quality: Are the heads dirty or magnetized? Are you using good quality tape? Is the proper NR System select switch on?
- Unable to select record mode: Are the record protection tabs on the tape in place?

the ability of the recorder to record high frequencies (MOL) decreases. This phenomenon is called self-biasing.

How Dolby HX Pro Solution

The Dolby HX Pro monitors the high-frequency content of the program material and adjusts the recorder bias oscillator to maintain a constant total bias level. The result is improved high-frequency response and lower distortion. Depending on the type of tape, the improvement in headroom can be 6 dB or more.

The Benefits

With Dolby HX Pro, it is easier to make more accurate recordings of the kind of music which contains high-level high frequencies. The improvement is similar to that of high-performance tape over conventional tape, so regardless of the type of tape used, the results will sound better. Most important of all, Dolby HX Pro requires no decoding process. Once the tape is recorded with it, the improvements will be realized when playing the tape back on any machine.

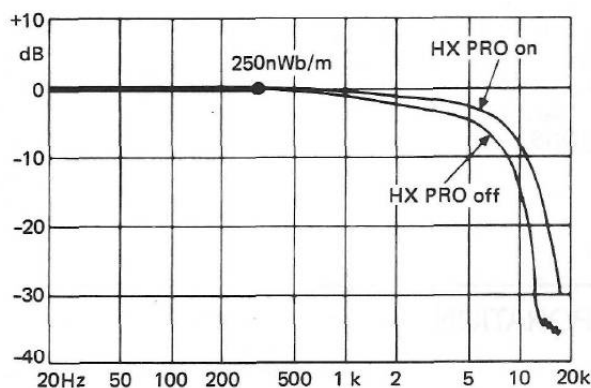

Example of improved frequency response using Dolby HX Pro function

Specifications

Track System 4-Track, 2-Channel Stereo

Heads 3: 1 Erase, 1 Record and 1

Playback (Combination)

Type of Tape Cassette tape C-60 and C-90
(Philips type)

Tape Speed 4.8 cm/sec. (1-7/8 ips)

Motors 2: 1 DC Servo motor

(for capstan drive)

IDC motor

(for reel drive)

Wow and Flutter

0.045 % (W. RMS)

Frequency Response (Overall) -20 dB

15 - 21,000 Hz ± 3 dB Metal Tape

15-20,000 Hz ± 3 dB CrO₂ Tape

15 - 18,000 Hz ± 3 dB Normal Tape

Signal-to-Noise Ratio (Overall)

60 dB (NROFF 3% THD Level,
Weighted)

70 dB (Dolby B in, over 5 kHz),

80 dB (Dolby C in, over 1 kHz),

Fast Winding Time Approximately 85

seconds for C-60

Inputs Line: 60 mV, 50k ohms

Outputs Line: 0.44 V for load impedance

of 50k ohms or more

Headphones: 2 mW/8 ohms load

Power Requirements 120/220/240 V

AC, 50/60 Hz (General export
models)

120VAC, 60Hz (U.S.A./Canada)

220 V AC, 50 Hz (Europe)

" 240 V AC, 50 Hz (U.K./Australia)

Power Consumption 18 W

Dimensions (W x H x D)

435 X 149 x 355 mm

(17-1/8" X 5-7/8" X 14")

Weight 6.9 kg (15.3 lbs.)

Standard Accessories

Wireless Remote Control Unit

RC-393, Batteries (SUM-3, "AA",

"R6" type) x 2, Input-output con-

nection cords X 2

- Specifications were determined using metal tape except as noted.
- Improvements may result in specifications or features changing without notice.
- Photos and illustrations may differ slightly from production models.

THIS DIGITAL APPARATUS DOES NOT EXCEED THE CLASS B LIMITS FOR RADIO NOISE EMISSIONS FROM DIGITAL APPARATUS AS SET OUT IN THE RADIO INTERFERENCE REGULATIONS OF THE CANADIAN DEPARTMENT OF COMMUNICATIONS.

LE PRESENT APPAREIL NUMERIQUE N'EMET PAS DE BRUITS RADIOELECTRIQUES DEPASANT LES LIMITES APPLICABLES AUX APPAREILS NUMERIQUES DE CLASSE B PRESCRITES DANS LE REGLEMENT SUR LE BROUILLAGES RADIOELECTRIQUE EDICTE PAR LE MINISTERS DES COMMUNICATIONS DU CANADA.

J E A C C O R P O R A T I O N

Musashino Center Bldg., 1-19-18, Nakacho, Musashino-shi, Tokyo 180, Japan Phone: (0422) 52-5081

TEAC AMERICA, INC.

7733 Telegraph Road, Montebello, California 90640 Phone: (213) 726-0303

TEAC CANADA LTD.

340 Brunei RD, Mississauga, Ontario L4Z 2C2, Canada Phone: 416-890-8008

TEAC UK LIMITED

5 Marlin House, Marlin's Meadow, The Croxley Centre, Watford, Herts, WD1 8YA, U.K. Phone: 0923-225235

TEAC DEUTSCHLAND GmbH

Bahnstrasse 12, 6200 Wiesbaden-Erbenheim, West Germany Phone: 06121-71580

TEAC FRANCE S.A.

17, Rue Alexis-de-Tocqueville CE 005 92182 Antony Cedex, France Phone: (1) 42.37.01.02

TEAC AUSTRALIA PTY., LTD.

106 Bay Street, Port Melbourne Victoria 3207, Australia Phone: (03) 646-1733

PRINTED IN JAPAN 0790U5-M-0404A