

technical manual

TABLE OF CONTENTS

CHASSIS LAYOUT	2	PRE-AMPLIFIER CIRCUIT BOARD DIAGRAM	7
PRECAUTIONS	3	AUXILIARY INPUT CIRCUIT BOARD DIAGRAM	7
BIAS (IDLING CURRENT) ADJUSTMENT	3	TONE AMPLIFIER CIRCUIT BOARD DIAGRAM	8
TROUBLE SHOOTING	4	EQUALIZER AMPLIFIER CIRCUIT BOARD DIAGRAM	8
STABILIZER CIRCUIT BOARD DIAGRAM	5	RECTIFIER CIRCUIT BOARD DIAGRAM	9
LOUDNESS AND MUTING CIRCUIT BOARD DIAGRAM	5	RELAY CIRCUIT BOARD DIAGRAM	9
PHONO INPUT CIRCUIT BOARD DIAGRAM	5	SCHEMATIC DIAGRAM	10
MAIN AMPLIFIER CIRCUIT BOARD DIAGRAM	6	ADDENDUM	12
FILTER CIRCUIT BOARD DIAGRAM	6	PARTS LIST	12

CHASSIS LAYOUT

1. C003, Ripple Filter
2. C006, Ripple Filter
3. Volume Control
4. F003, DC Fuse, +B, R-ch.
5. Function Selector
6. C007, Ripple Filter
7. Treble Control
8. Switch, Treble Turn-over, Roll-off
9. Switch, Bass Turn-over, Roll-off
10. Bass Control
11. Switch, Power Supply
12. D903, Rectifier
13. D905, Rectifier
14. F001, DC Fuse, +B L-ch.
15. F002, DC Fuse, -B, L-ch.
16. T001, Power Transformer
17. D906, Rectifier
18. D904, Rectifier
19. Voltage Selector
20. T002, Power Transformer
21. J001, AC Outlet
22. RY901, Delay Relay
23. Q003, Power Transistor, R-ch.
24. F004, DC Fuse, -B, R-ch.
25. Q612, Driver Transistor, R-ch.
26. Terminal, Tape Monitor
27. Q004, Power Transistor, R-ch.
28. VR602, Idling Current Adj., R-ch.
29. Q611, Driver Transistor, R-ch.
30. Q002, Power Transistor, L-ch.
31. Terminal, Phono, Aux Input
32. Q605, Driver Transistor, L-ch.
33. Q001, Power Transistor, L-ch.
34. Q606, Driver Transistor, L-ch.
35. VR601, Idling Current Adj., L-ch.
36. Main Amp. Circuit Board
37. Equalizer Amp. Circuit Board
38. C004, Ripple Filter
39. C005, Ripple Filter

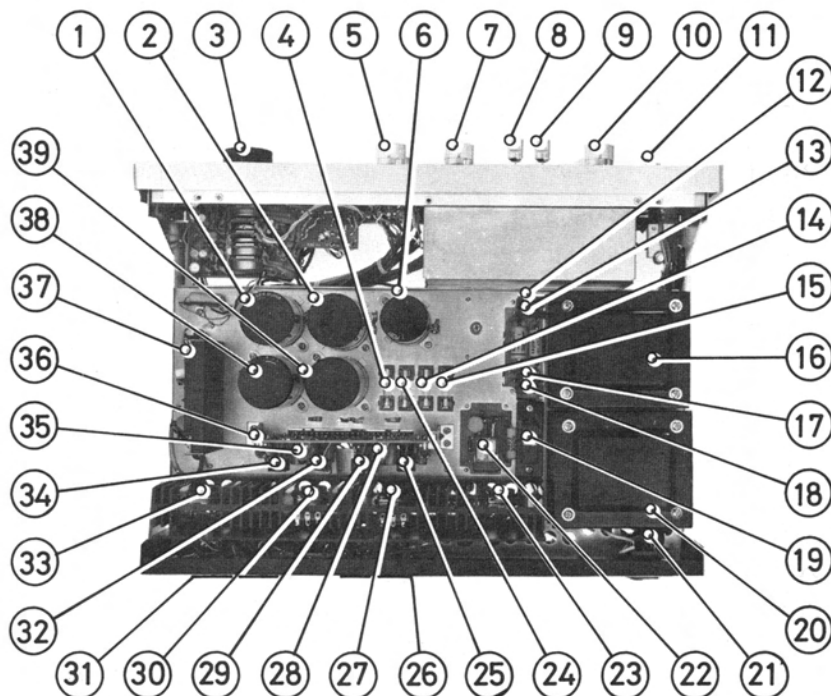

40. Stabilizer Circuit Board
41. Speakers Selector
42. Switch, Low Filter
43. Switch, High Filter
44. Filter Switch Circuit Board
45. Switch, Monitor
46. Switch, Mode
47. Switch, Loudness
48. Switch, Muting
49. Loudness Switch Circuit Board
50. Balance Control
51. Volume Control
52. Aux Input Circuit Board
53. Bracket, Main Amp. Circuit Board
54. Switch, Phono Input Impedance
55. Switch, Phono Input Sensitivity

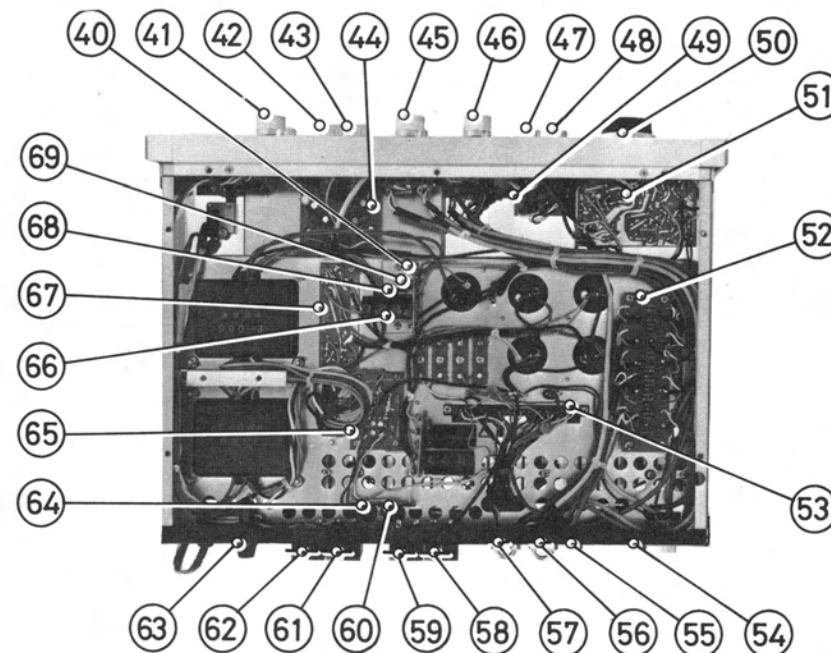

56. Terminal, Pre OUT, Main IN, R-ch.
57. Terminal, Pre OUT, Main IN, L-ch.
58. Terminal, Speaker-1, R-ch.
59. Terminal, Speaker-2, R-ch.
60. Circuit Breaker, R-ch.
61. Terminal, Speaker-1, L-ch.
62. Terminal, Speaker-2, L-ch.

63. F005, AC Fuse
64. Circuit Breaker, L-ch.
65. Relay Circuit Board
66. D902, Zener Diode
67. Rectifier Circuit Board
68. Q901, Stabilizer Transistor
69. D901, Rectifier

PRECAUTIONS

1. Always disconnect the chassis from power line when soldering. Turning the power switch OFF is not enough. Power line leakage passing through the heating element may destroy the transistors.
2. Never attempt to do any work on the transistor amplifiers without first disconnecting the AC line cord and waiting until the power supply filter capacitors have discharged.
3. Replacement for output and driver transistors, if necessary, must be made from the same beta group as the original type.
4. If one output transistor burns out (open or short) always remove all output transistors in that channel and check the bias

adjustment, the control and other parts in the network with an ohm-meter before inserting a new transistor. All transistors in one channel will be destroyed if the base biasing circuit is open on the emitter end.

5. When mounting a replacement power transistor, be sure the bottom of the flange, the mica insulators and the surface of the heat sink are free of foreign matter, for they may cause transistors failure.
6. Silicon grease must be applied between the transistor and the mica insulator, and between the mica insulator and the heat sink for better heat conduction.

BIAS (IDLING CURRENT) ADJUSTMENT

Adjust Idling Current using a DC milli-volt meter.

1. Set Volume Control to minimum position = no signal input.
2. Connect the plus lead of a DC mV meter to pin No.4 (on Main Amp. PCB) and the minus lead of a DC mV meter to pin No.3 (see below).
3. Rotate VR601 potentiometer (on Main Amp. PCB) to obtain a 15mV reading on DC mV meter.
4. Repeat the steps 2 and 3 as above for Right channel (use pins No.1, No.2 and potentiometer VR602). Plus lead to pin No.1 and Minus lead to pin No.2.

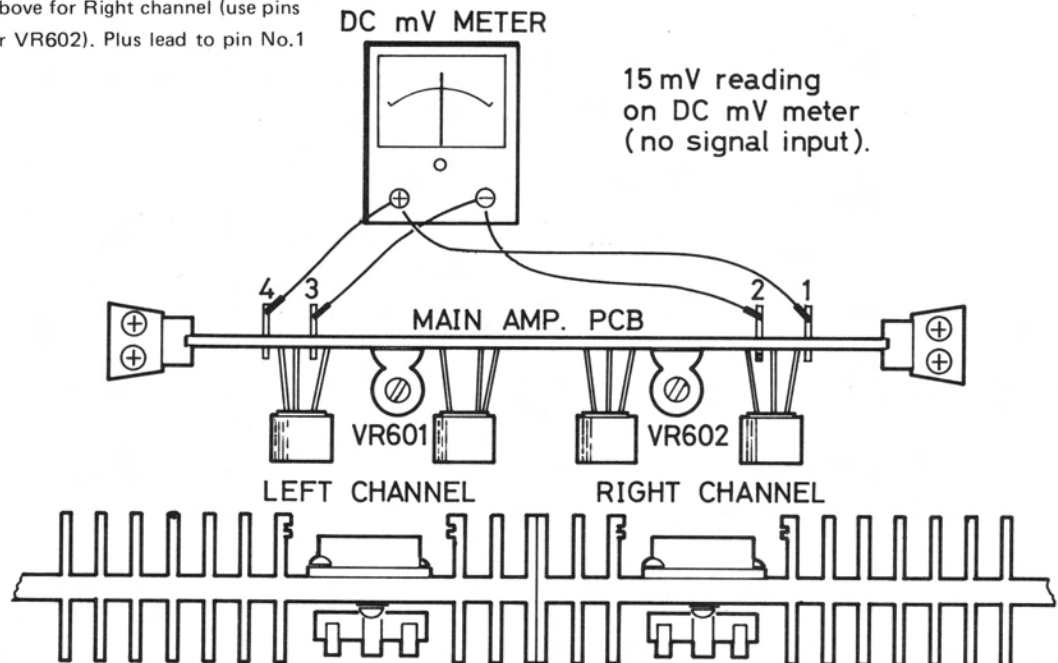

TROUBLE SHOOTING

NOT WORKING

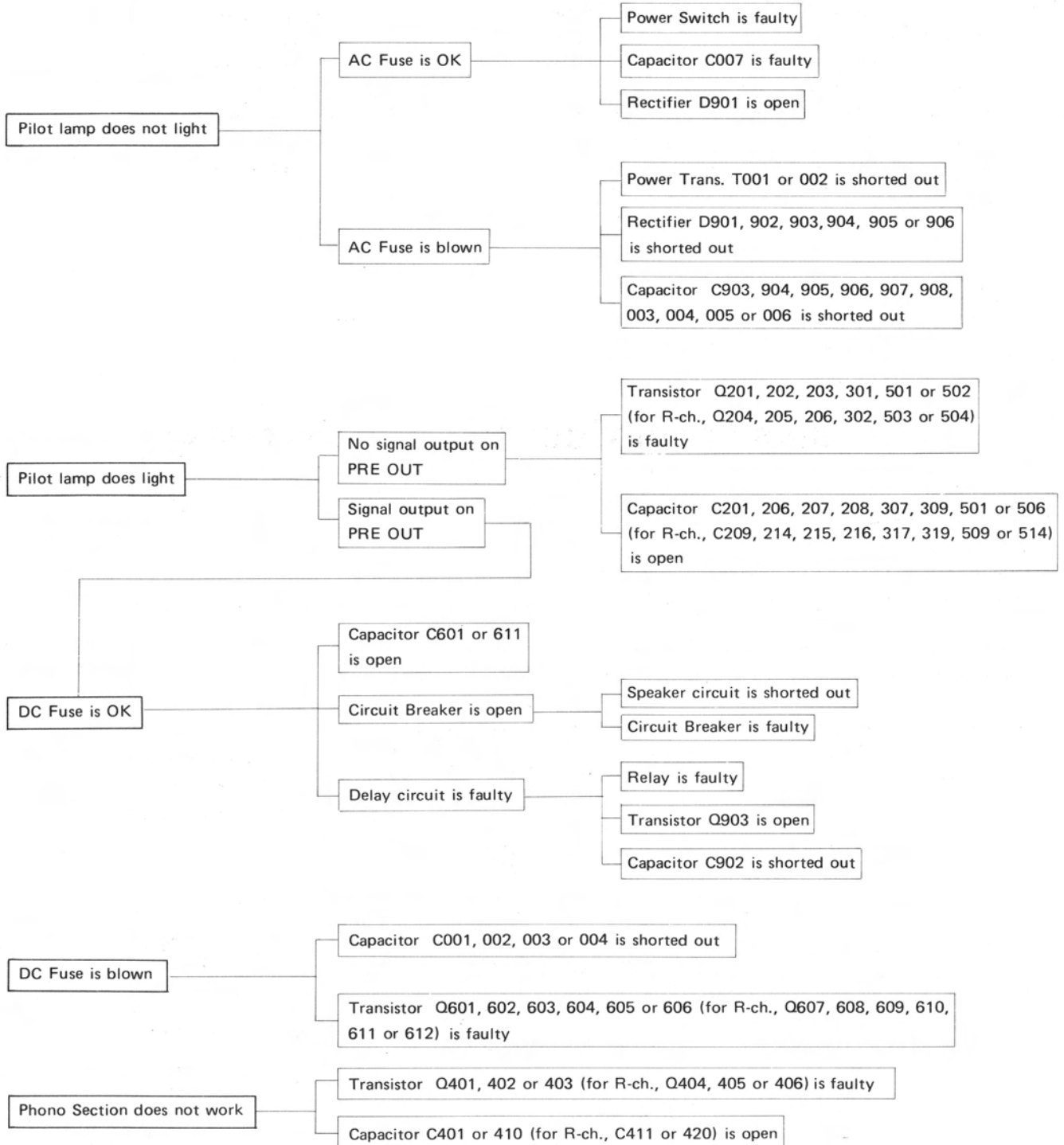

STABILIZER CIRCUIT BOARD DIAGRAM

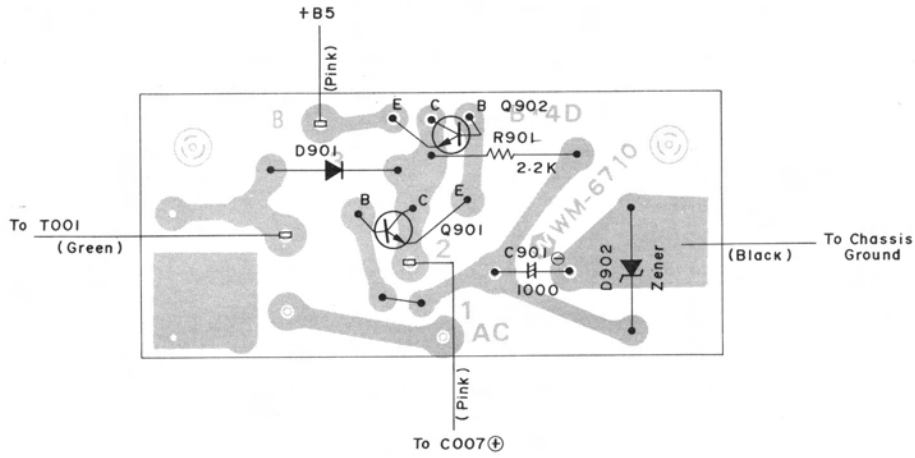

LOUDNESS AND MUTING CIRCUIT BOARD DIAGRAM

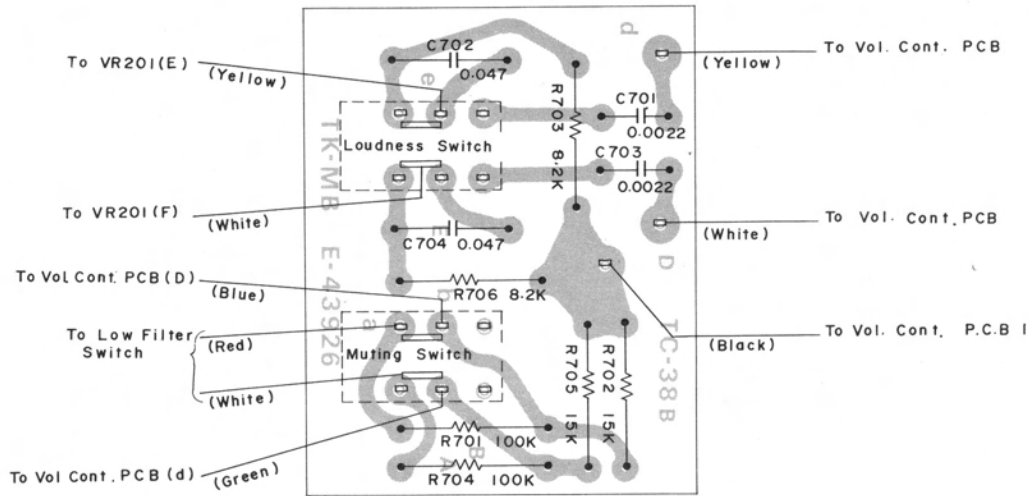

PHONO INPUT CIRCUIT BOARD DIAGRAM

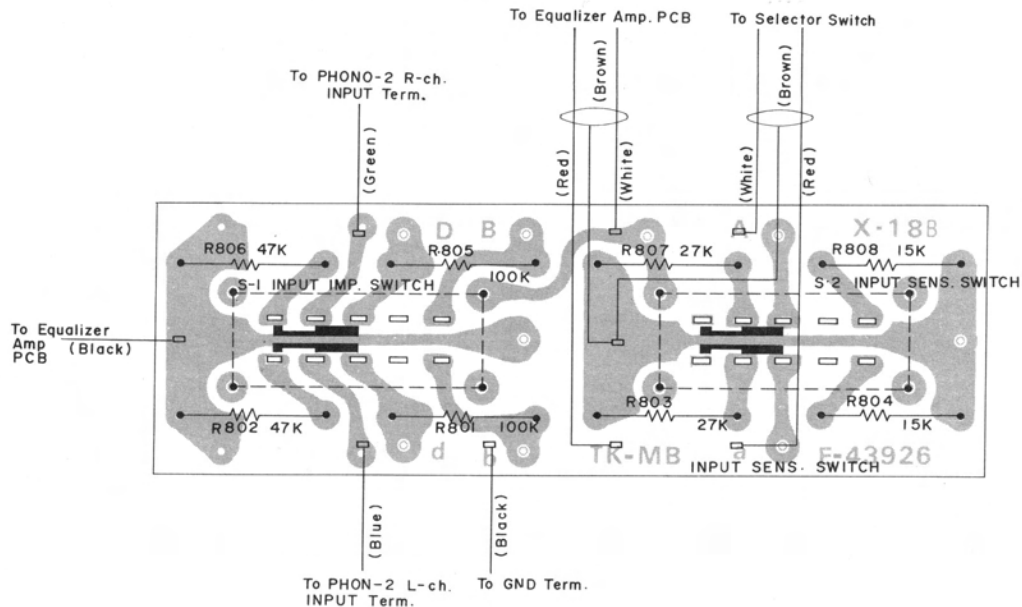

MAIN AMPLIFIER CIRCUIT BOARD DIAGRAM

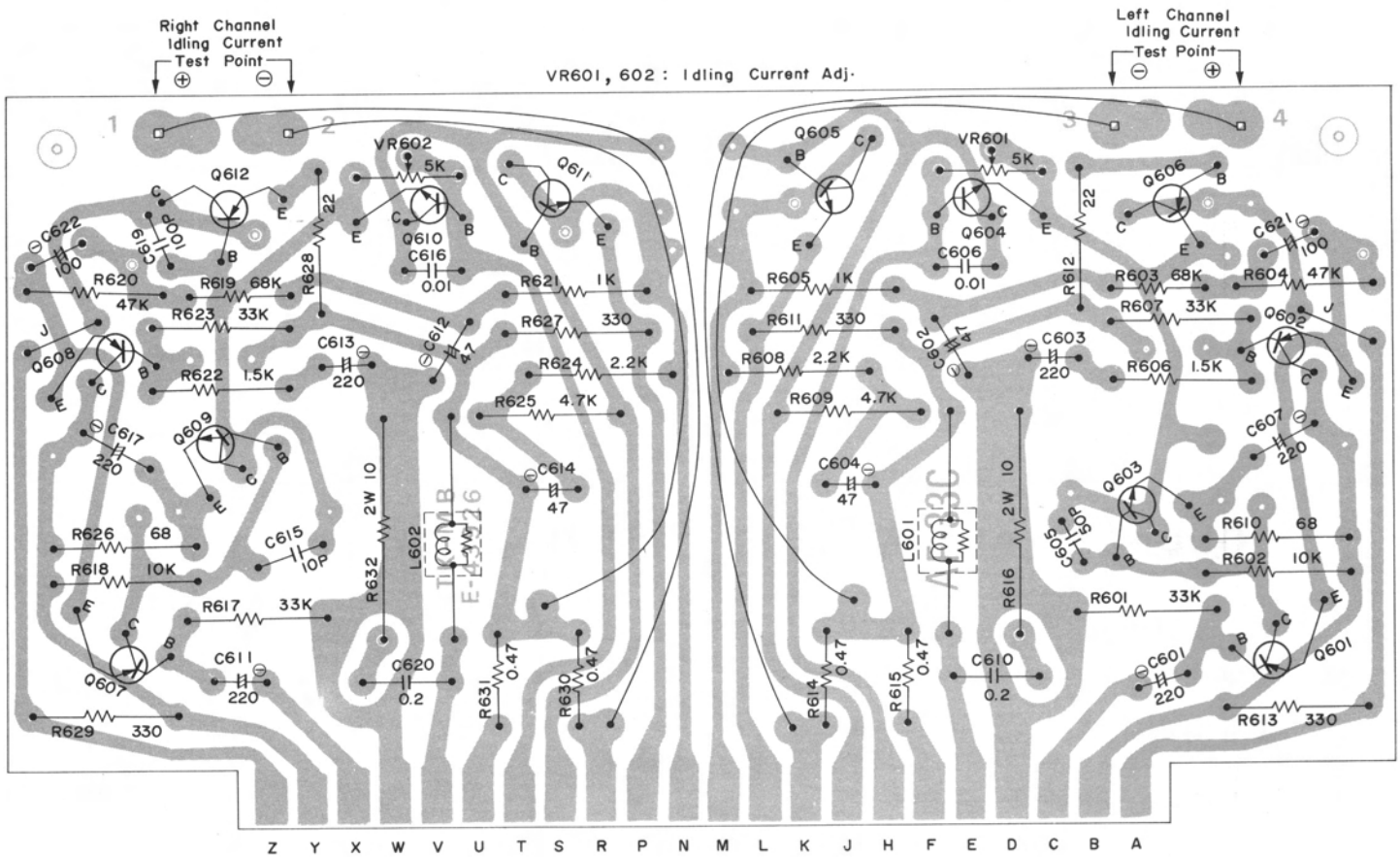

FILTER CIRCUIT BOARD DIAGRAM

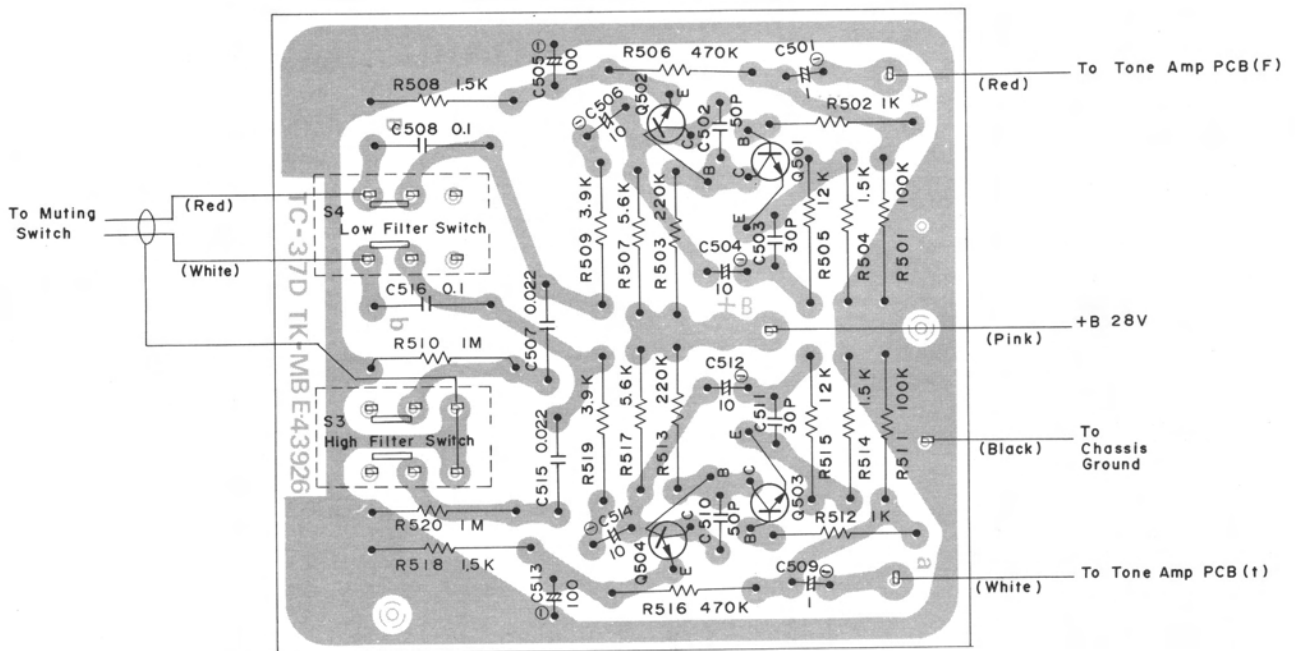

PRE-AMPLIFIER CIRCUIT BOARD DIAGRAM

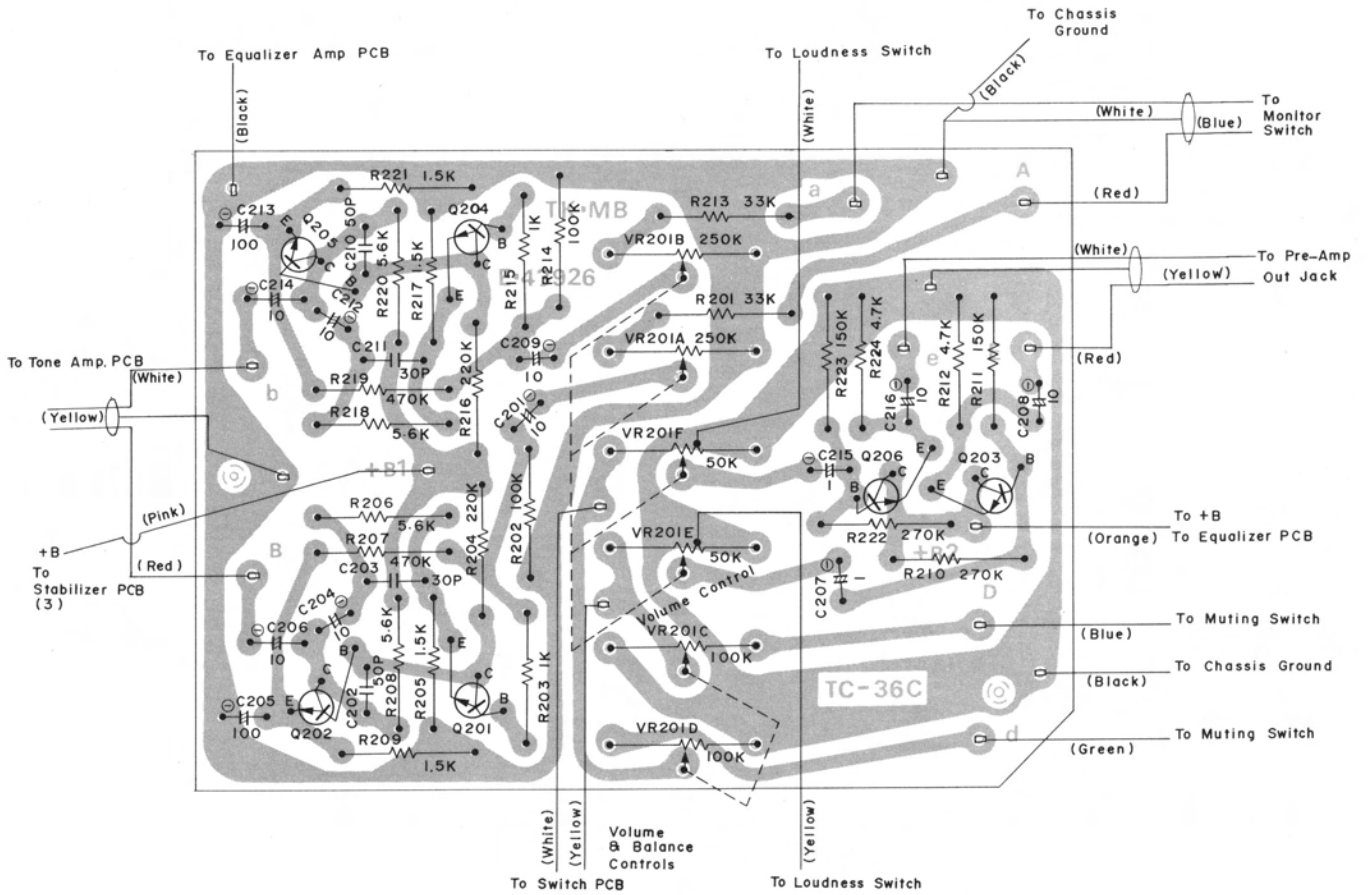

AUXILIARY INPUT CIRCUIT BOARD DIAGRAM

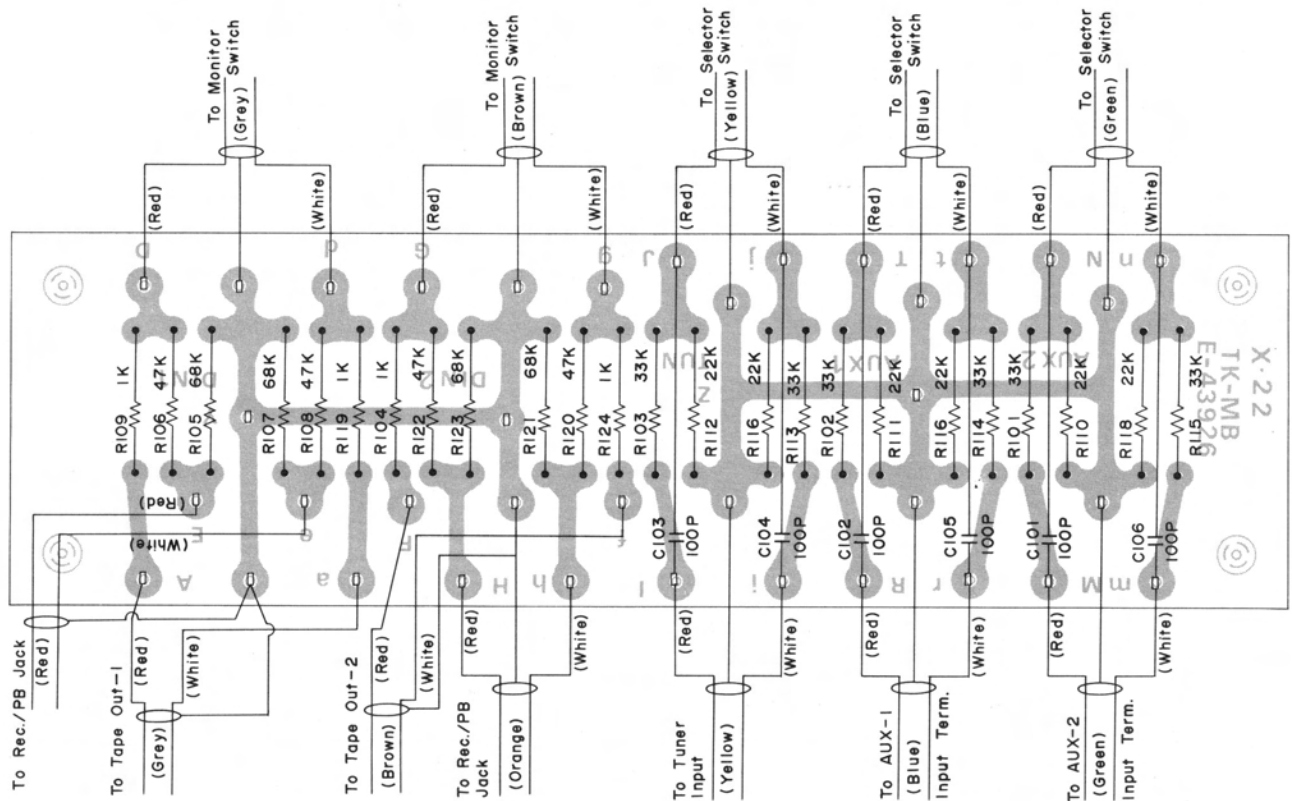

TONE AMPLIFIER CIRCUIT BOARD DIAGRAM

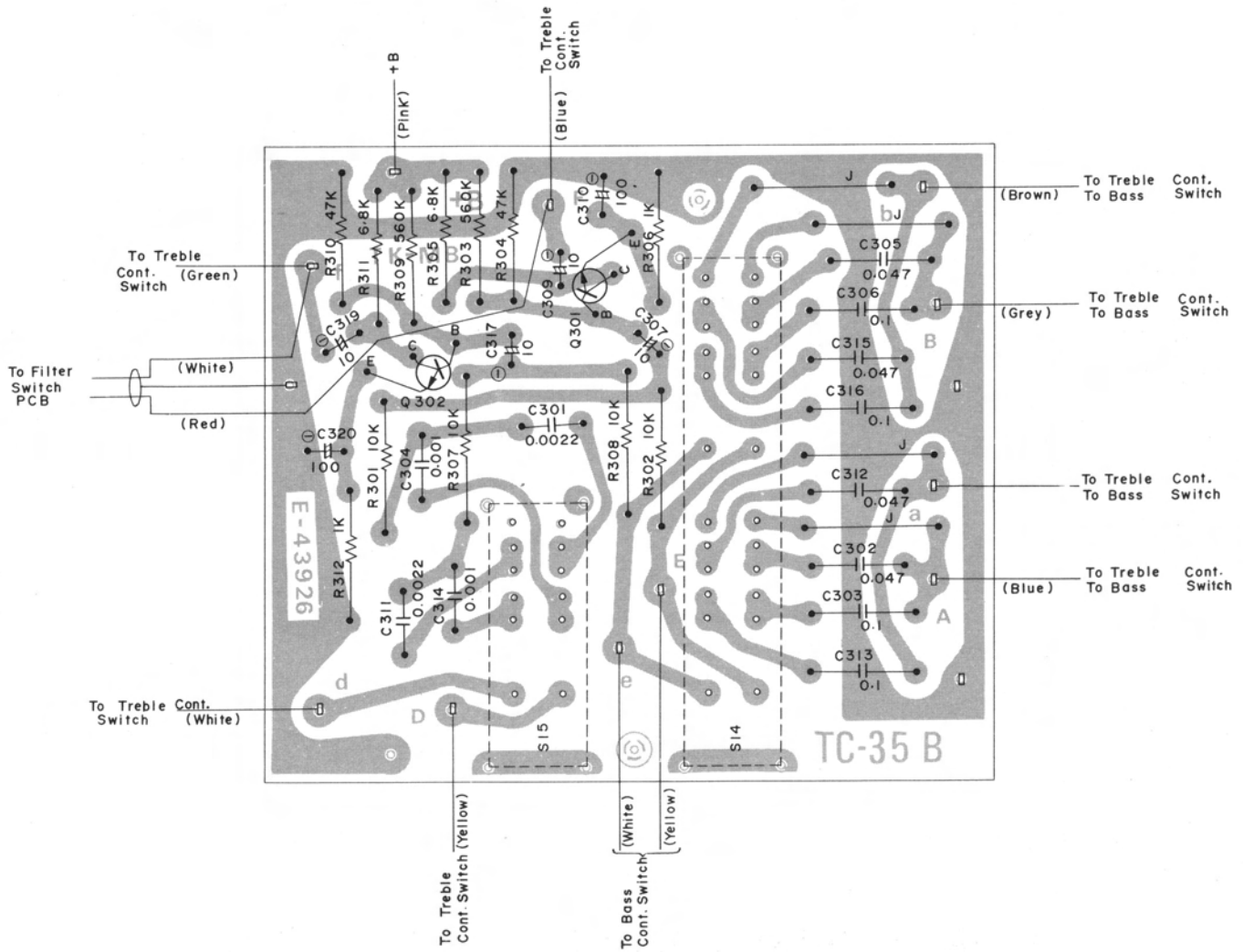

EQUALIZER AMPLIFIER CIRCUIT BOARD DIAGRAM

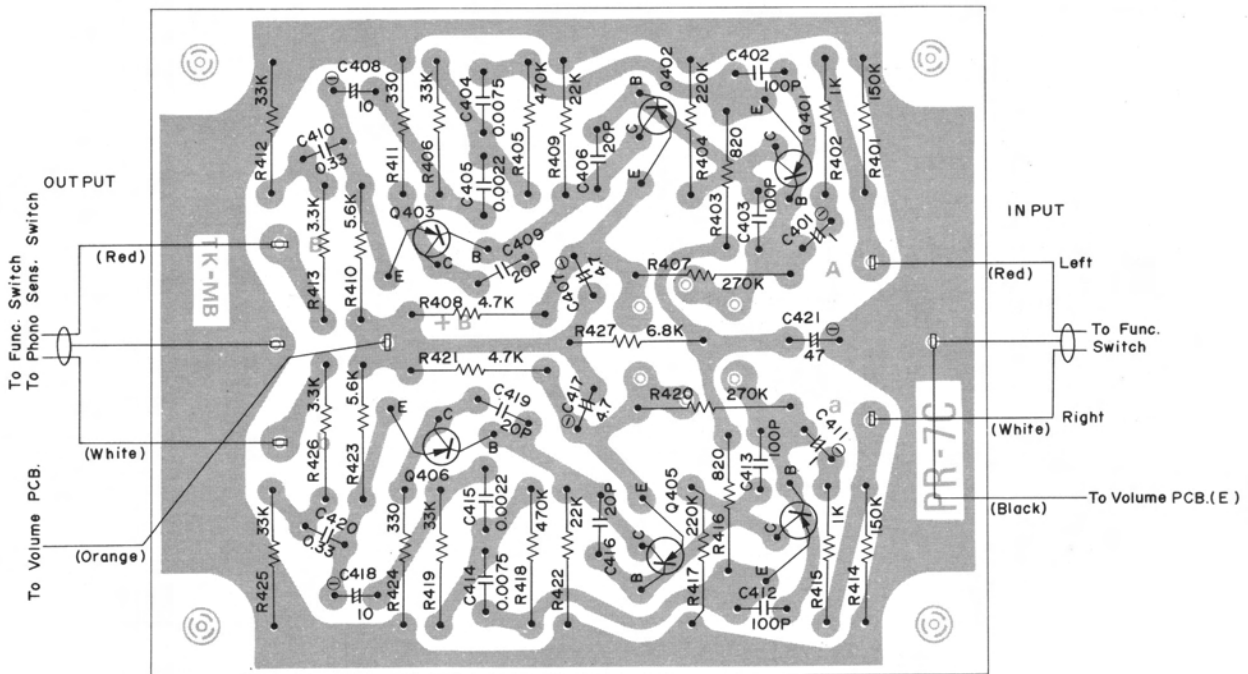

RECTIFIER CIRCUIT BOARD DIAGRAM

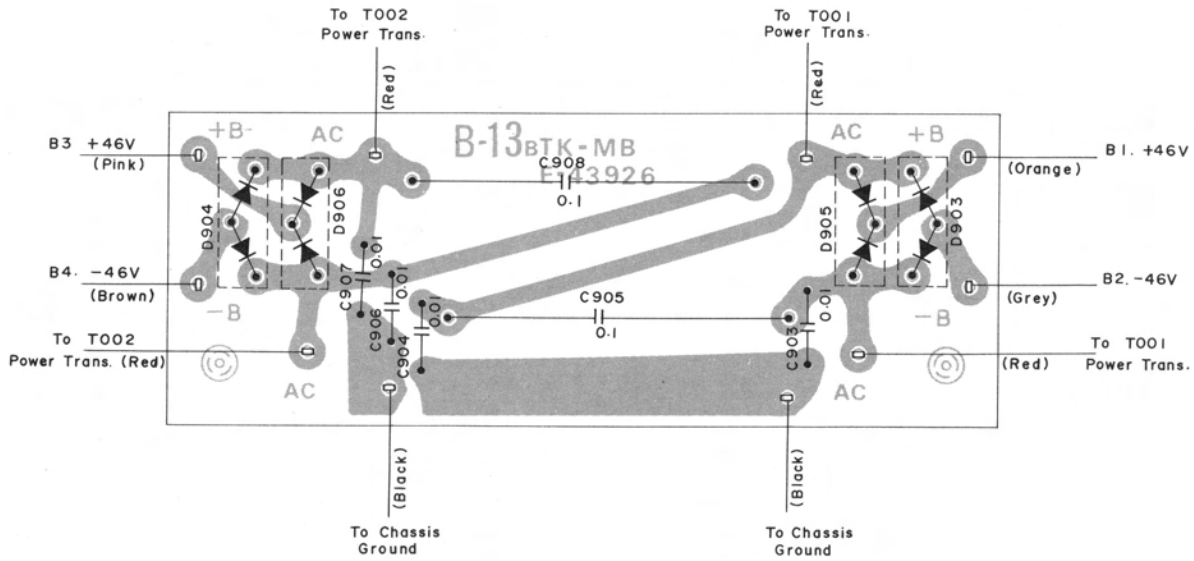

RELAY CIRCUIT BOARD DIAGRAM

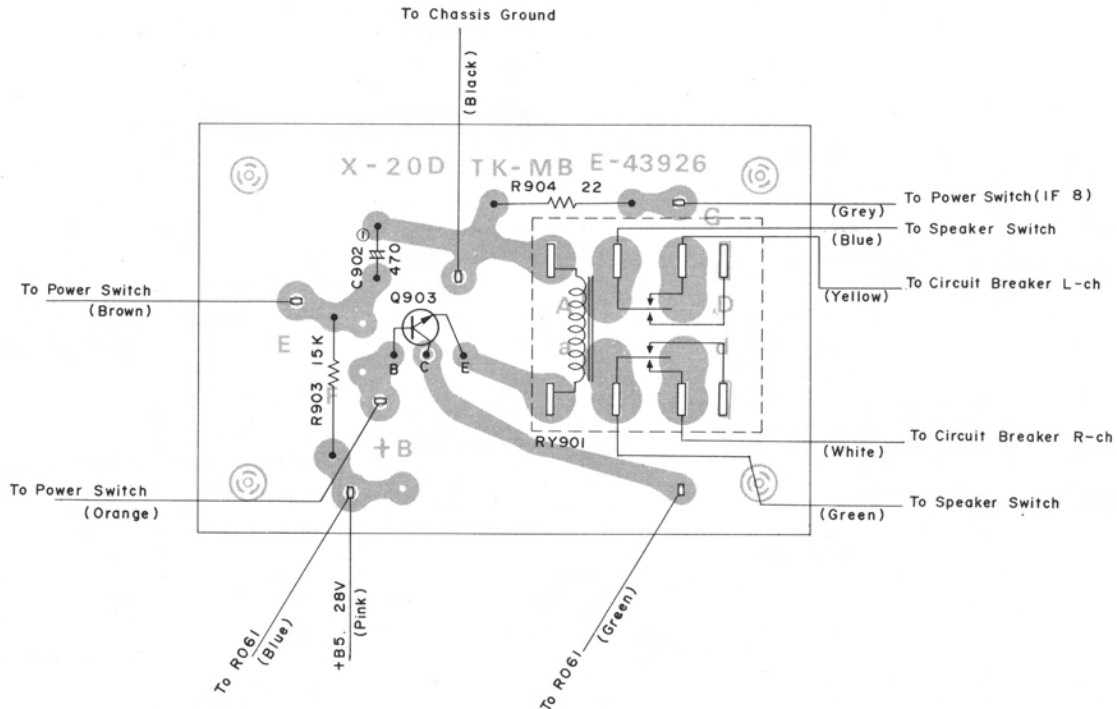

SCHEMATIC DIAGRAM

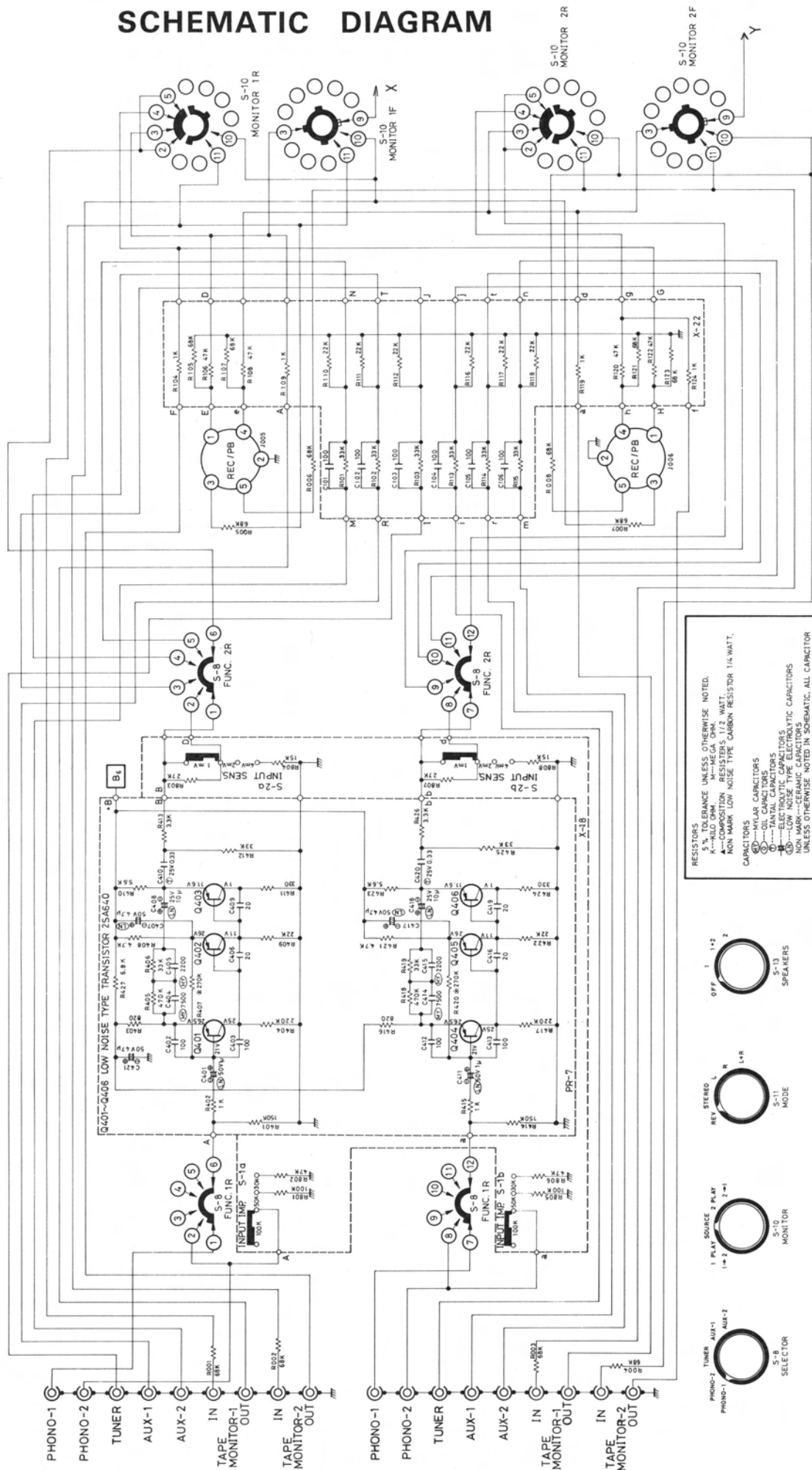

RESISTORS
5% TOLERANCE UNLESS OTHERWISE NOTED.
K—KILLOHM RESISTOR 1/4 WATT.
M—MILLIOHM RESISTOR 1/4 WATT.
NOM MARK—LOW NOISE TYPE CARBON RESISTOR 1/4 WATT.

CAPACITORS
M—MICROFARAD CAPACITORS
T—TANTALUM CAPACITORS
O—OIL CAPACITORS
S—SPECIAL LOW NOISE TYPE ELECTROLYTIC CAPACITORS
NOM MARK—CERAMIC CAPACITORS
UNLESS OTHERWISE NOTED IN SCHEMATIC, ALL CAPACITOR VALUES ARE EXPRESSED IN PFD.

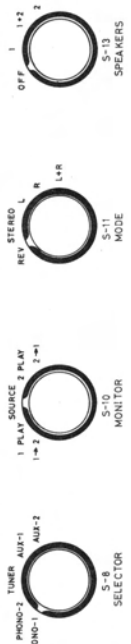

0207 ~ 0208, 0301, 0302, 0303 ~ 0304, 25C1327 (or 25C1328)

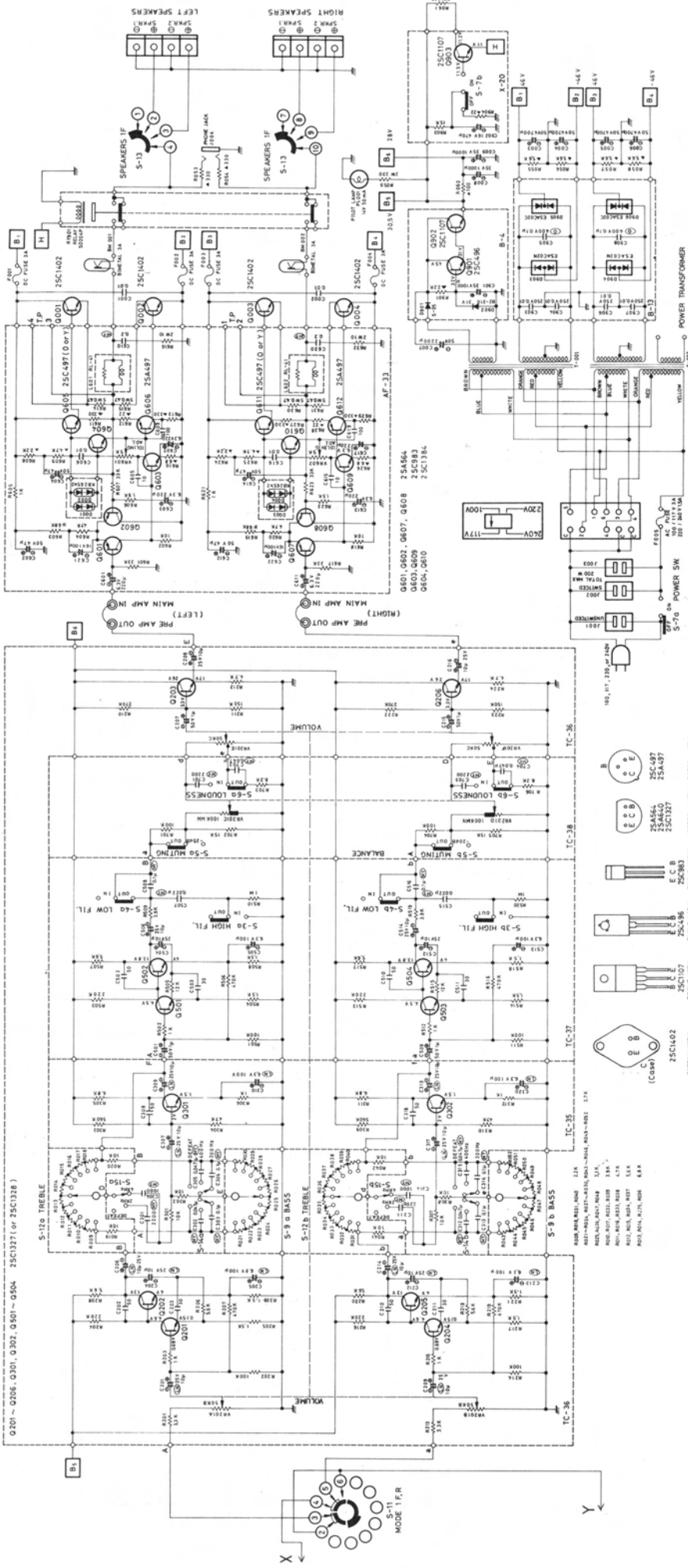

- 25C1402 (C901)
- TC-36
- TC-37
- TC-38
- TC-39

ADDENDUM

ADDENDUM: CHANGES

The following changes have been made on the Main Amplifier Circuit Board concerns from the production units of Serial No. E 67611 and F 012161 and on.

1. Bracket, Main Amp PCB — changed from type CR6 (Part No. 648211117) to type CR4 (Part No. 648211120).

DIFFERENCE: The new type has the insert portion slightly shorter than the old type.

2. MAIN Amp PCB — changed from the board type "AF-33C" (Part No. 140600651) to the type "AF-33D" (Part No. 140600655).

REASON: In accordance to the change incorporated as the item 1 above.

NOTE: Main Amp PCB w/components is also changed from Part No. 141610231 to Part No. 141610240 accordingly to the change of the Printed Circuit Boards.

CAUTION: Do not use the new Main Amp PCB "AF-33D" on the old type Bracket, as the electrical connections may become unstable causing damages to transistors and other parts.

PARTS LIST

CHASSIS PARTS

Schematic Location	Part No.	Description
	116310061	Knob, Tone Turn-over switch
	116310063	Knob, Balance Control
	116310064	Knob, Volume Control
	116210009	Knob, Push Switch, Power, Muting, etc.
	116320062	Knob, Func., Mode, Tone, etc.
S7	614010103	Switch, Power
S8	601011239	Switch, Func. Selector
S9, 12	601011238	Switch, Treble and Bass
S10	601011227	Switch, Monitor
S11	601011240	Switch, Mode
S13	601011225	Switch, Speakers
J001,002,003	648211116	AC Outlet
J004	626110022	Jack, Headphones
J005,006	625001112	Pin Jack, 5P
	624100104	Pin Jack, 4P, RCA Type
	624100208	Pin Jack, 8P, RCA Type
	624100210	Pin Jack, 10P, RCA Type
	642400104	Output Terminal, 4P
	648211114	Bracket, AC Fuse
	648211117	Bracket, Main Amp. PCB
	648211118	Socket, Power Transistor
	648211119	Bracket, DC Fuse
	351140005	Lamp, 14V 50mA
BM001,002	330111011	Circuit Breaker
Q001,002, Q003,004	301201139	Transistor, 2SC1402, Power Amp.
D001,002, D003,004	300212002	Varistor, KB-265
T001,002	205001329	Transformer, Power Supply "C type"
F001,002,003, F004, 005	341220030	Fuse, 3A-3AG, DC and (AC 117V) Circuit
RESISTORS		
R001,002,003, R004,005,006, R007,008	552068322	Carbon Film, 68K ±5%, 1/4W

Schematic Location	Part No.	Description
R009,018, R031,040	552022222	Carbon Film, 2.2K ±5%, 1/4W
R010,017, R032,039	552039222	Carbon Film, 3.9K ±5%, 1/4W
R001,016, R033,038	552047222	Carbon Film, 4.7K ±5%, 1/4W
R012,015, R034,037	552056222	Carbon Film, 5.6K ±5%, 1/4W
R013,014, R035,036	552068222	Carbon Film, 6.8K ±5%, 1/4W
R019,020, R041,042	552010322	Carbon Film, 10K ±5%, 1/4W
R021,022,023, R024,027,028, R029,030,043, R044,045,046, R049,050,051, R052	552027222	Carbon Film, 2.7K ±5%, 1/4W
R025,026, R047,048	552033222	Carbon Film, 3.3K ±5%, 1/4W
R053,054	551033133	Composition, 330 ±10%, 1/2W
R055,056, R057,058	551056233	Composition, 5.6K ±10%, 1/2W
R059,061	553133163	Metal Oxide, 330 ±10%, 3W
R060	551010133	Composition, 100 ±10%, 1/2W
CAPACITORS		
C001,002	440100985	Ceramic, 0.01 mfd, 250V
C003,004, C005,006	400400449	Electrolytic, 4700 mfd, 50V
C007	400220449	Electrolytic, 2200 mfd, 50V
C008,009	402100439	Electrolytic, 1000 mfd, 35V

AUX INPUT DIVIDING CIRCUIT BOARD

Schematic Location	Part No.	Description
RESISTORS		
R101,102,103, R113,114,115 }	552033322	Carbon Film, 33K ±5%, 1/4W
R104,109, R119,124 }	552010222	Carbon Film, 1K ±5%, 1/4W
R105,107, R121,123 }	552068322	Carbon Film, 68K ±5%, 1/4W
R106,108, R120,122 }	552047322	Carbon Film, 47K ±5%, 1/4W

Schematic Location	Part No.	Description
R110,111,112 R116,117,118 }	552022322	Carbon Film, 22K ±5%, 1/4W
CAPACITORS		
C101,102,103, C104,105,106 }	440101183	Ceramic, 100pF ±10%, 250V
	140800147	Printed Circuit Board "X-22"
	141810149	AUX Input Circuit Board Assembly

PRE-AMPLIFIER CIRCUIT BOARD

Schematic Location	Part No.	Description
RESISTORS		
R201,213	552033222	Carbon Film, 3.3K ±5%, 1/4W
R202,214	552010422	Carbon Film, 100K ±5%, 1/4W
R203,215	552010222	Carbon Film, 1K ±5%, 1/4W
R204,216	552022422	Carbon Film, 220K ±5%, 1/4W
R205,209 R217,221 }	552015222	Carbon Film, 1.5K ±5%, 1/4W
R206,208, R218,220 }	552056222	Carbon Film, 5.6K ±5%, 1/4W
R207, 219	552047422	Carbon Film, 470K ±5%, 1/4W
R210,222	552027422	Carbon Film, 270K ±5%, 1/4W
R211,223	552015422	Carbon Film, 150K ±5%, 1/4W
R212,224	552047222	Carbon Film, 4.7K ±5%, 1/4W
VR201	525121118	Variable, Vol. and Bal. Control (100 kmn. 50k Bx2,50kcx2)

Schematic Location	Part No.	Description
CAPACITORS		
C201,204,206, C209,212,214 }	412100729	Electrolytic, 10 mfd, 25V (low noise)
C202,210	440501283	Ceramic, 50pF ±10%, 250V
C203,211	440301283	Ceramic, 30pF ±10%, 250V
C205,213	412100509	Electrolytic, 100 mfd, 6.3V
C207,215	402100749	Electrolytic, 1 mfd, 50V
C208,216	402100629	Electrolytic, 10 mfd, 25V
TRANSISTORS		
Q201,202,203, Q204,205,206 }	301201134	2SC1327
	140700735	Printed Circuit Board "TC-36"
	141710227	Pre-amp. Circuit Board Assembly

TONE AMPLIFIER CIRCUIT BOARD

Schematic Location	Part No.	Description
RESISTORS		
R301,302, R307,308 }	552010322	Carbon Film, 10K ±5%, 1/4W
R303,309	552056422	Carbon Film, 560K ±5%, 1/4W
R304,310	552047322	Carbon Film, 47K ±5%, 1/4W
R305,311	552068222	Carbon Film, 6.8K ±5%, 1/4W
R306,312	552010222	Carbon Film, 1K ±5%, 1/4W
CAPACITORS		
C301,311	452221032	Mylar Film, 0.0022 mfd ±5%, 50V
C302,305, C312,315 }	452470932	Mylar Film, 0.047 mfd ±5%, 50V
C303,306, C313,316 }	452100932	Mylar Film, 0.1 mfd ±5%, 50V
C304,314	452101032	Mylar Film, 0.001 mfd ±5%, 50V

Schematic Location	Part No.	Description
C307,309, C317,319 }	412100629	Electrolytic, 10 mfd, 25V (low noise)
C308,318	440501283	Ceramic, 50pF ±10%, 250V
C310,320	412100509	Electrolytic, 100 mfd, 6.3V (low noise)
TRANSISTOR		
Q301,302	301201134	2SC1327
SWITCHES		
S14	611001627	Bass Turn-over, Roll-off
S15	611001626	Treble Turn-over, Roll-off
	140700737	Printed Circuit Board "TC-35"
	141710229	Tone Amp. Circuit Board Assembly

EQUALIZER AMP. CIRCUIT BOARD

Schematic Location	Part No.	Description
RESISTORS		
R401,414	552015422	Carbon Film, 150K ±5%, 1/4W
R402,415	552010222	Carbon Film, 1K ±5%, 1/4W
R403,416	552082122	Carbon Film, 820 ±5%, 1/4W
R404, 417	552022422	Carbon Film, 220K ±5%, 1/4W
R405,418	552047422	Carbon Film, 470K ±5%, 1/4W
R406,412, } R419,425 }	552033322	Carbon Film, 33K ±5%, 1/4W
R407,420	552027422	Carbon Film, 270K ±5%, 1/4W
R408,421	552047222	Carbon Film, 4.7K ±5%, 1/4W
R409, 422	552022322	Carbon Film, 22K ±5%, 1/4W
R410,423	552056222	Carbon Film, 5.6K ±5%, 1/4W
R411,424	552033122	Carbon Film, 330 ±5%, 1/4W
R413,426	552033222	Carbon Film, 3.3K ±5%, 1/4W
R427	552068222	Carbon Film, 6.8K ±5%, 1/4W
CAPACITORS		
C401,411	412100749	Electrolytic, 1 mfd, 50V

Schematic Location	Part No.	Description
C402,403, } C412,413 }	440101183	Ceramic, 100 pF ±10%, 250V
C404,414	452751032	Mylar Film, 7500 pF ±5%, 50V
C405,415	452221032	Mylar Film, 2200 pF ±5%, 50V
C406,409, } C416,419 }	440201283	Ceramic, 20 pF ±10%, 250V
C407,417	412470749	Electrolytic, 4.7 mfd, 50V
C408,418	412100629	Electrolytic, 10 mfd, 25V
C410,420	444330943	Tantalum, 0.33 mfd ±10%, 35V
TRANSISTORS		
Q401,402,403, } Q404,405,406 }	301001120	2SA640
	140500525	Printed Circuit Board "PR-7"
	141510125	Equalizer Circuit Board Assembly

FILTER SWITCH CIRCUIT BOARD

Schematic Location	Part No.	Description
RESISTORS		
R501,522	552010422	Carbon Film, 100K ±5%, 1/4W
R502,512	552010222	Carbon Film, 1K ±5%, 1/4W
R503,513	552022422	Carbon Film, 220K ±5%, 1/4W
R504,508, } R514,518 }	552015222	Carbon Film, 1.5K ±5%, 1/4W
R505,515	552012322	Carbon Film, 12K ±5%, 1/4W
R506,516	552047422	Carbon Film, 470K ±5%, 1/4W
R507,517	552056222	Carbon Film, 5.6K ±5%, 1/4W
R509,519	552039222	Carbon Film, 3.9K ±5%, 1/4W
R510,520	552010522	Carbon Film, 1M ±5%, 1/4W
CAPACITORS		
C501,509	402100749	Electrolytic, 1 mfd, 50V
C502,510	440501283	Ceramic, 50 pF ±10%, 250V

Schematic Location	Part No.	Description
C503,511	440301283	Ceramic, 30 pF ±10%, 250V
C504,506, } C512,514 }	402100629	Electrolytic, 10 mfd, 25V
C505,513	402100509	Electrolytic, 100 mfd, 6.3V
C507,515	452220932	Mylar Film, 0.022mfd ±5%, 50V
C508,516	452100832	Mylar Film, 0.1 mfd ±5%, 50V
TRANSISTORS		
Q501,502, } Q503,504 }	301201134	2SC1327
S3,4	614020402	Switch, High and Low Filter
	140700734	Printed Circuit Board "TC-37"
	141710226	Filter Switch Circuit Board Assembly

MAIN AMPLIFIER CIRCUIT BOARD

Schematic Location	Part No.	Description
RESISTORS		
R601,607, } R617,623 }	552033322	Carbon Film, 33K ±5%, 1/4W
R602, 618	552010322	Carbon Film, 10K ±5%, 1/4W
R603,619	552068322	Carbon Film, 68K ±5%, 1/4W

Schematic Location	Part No.	Description
R604,620	552047322	Carbon Film, 47K ±5%, 1/4W
R605,621	552010222	Carbon Film, 1K ±5%, 1/4W
R606,622	552015222	Carbon Film, 1.5K ±5%, 1/4W
R607,624	551022233	Composition, 2.2K ±10%, 1/2W
R609,625	551047233	Composition, 4.7K ±10%, 1/2W
R610,626	551068033	Composition, 68 ±10%, 1/2W

Schematic Location	Part No.	Description
R611,613, } R627,629 }	551033133	Composition, 330 ±10%, 1/2W
R612,628	551022033	Composition, 22 ±10%, 1/2W
R614,615, } R630,631 }	554147973	MPR, Cement, 0.47 ±10%, 5W
R616,632	554010053	Bath-tub, 10 ±10%, 2W
CAPACITORS		
C601,603,607, } C611,613,617 }	402220509	Electrolytic, 220 mfd, 6.3V
C602,604, } C612,614 }	402470649	Electrolytic, 47 mfd, 50V
C605,615	440101283	Ceramic, 10 pF ±10%, 250V
C606,616	440100985	Ceramic, 0.01 mfd, 250V
C608,618		Not Used
C609,619	440101183	Ceramic, 100 pF ±10%, 250V
C610,620	450200833	Mylar Film, 0.2 mfd ±10%, 50V
C621,622	402100519	Electrolytic, 100 mfd, 16V

Schematic Location	Part No.	Description
COIL		
L601,602	220401120	Anti-parasitic
TRANSISTORS		
Q601,602, } Q607,608 }	301001116	2SA564
Q603,609	301201140	2SC983
Q605,611	301201119	2SC497
Q606,612	301001116	2SA497
Q604,610	301201132	2SC1384
POTENTIOMETERS		
VR601,602	510502121	5K, Idling Current Adj.
	127012128	Heat Sink, for Pre-driver, Q603,609
	127012127	Heat Sink, for Driver, Q605,606,611,612.
	140600651	Printed Circuit Board "AF-33"
	141610231	Main Amp. Circuit Board Assembly

LOUDNESS CIRCUIT BOARD

Schematic Location	Part No.	Description
RESISTORS		
R701,704	552010422	Carbon Film, 100K ±5%, 1/4W
R702,705	552015322	Carbon Film, 15K ±5%, 1/4W
R703,706	552082222	Carbon Film, 8.2K ±5%, 1/4W
CAPACITORS		
C701,703	452221032	Mylar Film, 0.0022 mfd ±5%, 50V

Schematic Location	Part No.	Description
C702,704	452470932	Mylar Film, 0.047 mfd ±5%, 50V
S5, 6	614020402	Switch, Muting and Loudness
	140700736	Printed Circuit Board "TC-38"
	141710229	Loudness Circuit Board Assembly

PHONO SWITCH CIRCUIT BOARD

Schematic Location	Part No.	Description
RESISTORS		
R801,805	552010422	Carbon Film, 100K ±5%, 1/4W
R802,806	552047322	Carbon Film, 47K ±5%, 1/4W
R803,807	552027322	Carbon Film, 27K ±5%, 1/4W
R804,808	552015322	Carbon Film, 15K ±5%, 1/4W

Schematic Location	Part No.	Description
SWITCHES		
S1, 2		Phono Input Imp. and Input Sens. Selector
	140800148	Printed Circuit Board "X-18"
	141810150	Phono Switch Circuit Board Assembly

STABILIZER CIRCUIT BOARD

Schematic Location	Part No.	Description
RESISTOR		
R901	551022233	Composition, 2.2K ±10%, 1/2W
CAPACITOR		
C901	402100439	Electrolytic, 1000 mfd, 35V
TRANSISTORS		
Q901	301201131	2SC496

Schematic Location	Part No.	Description
Q902	301201133	2SC1107
DIODES		
D901	300919008	S-05, Rectifier
D902	300313010	BZ-310, Zener
	140800146	Printed Circuit Board "B-4"
	141810148	Stabilizer Circuit Board Assembly

RELAY CIRCUIT BOARD

Schematic Location	Part No.	Description
RESISTORS		
R903	552015322	Carbon Film, 15K ±5%, 1/4W
R904	551022033	Composition, 22 ±10%, 1/2W
CAPACITOR		
C902	402470516	Electrolytic, 470 mfd, 16V

Schematic Location	Part No.	Description
TRANSISTORS		
Q903	301201133	2SC1107
RY901	240111221	Relay
	140800142	Printed Circuit Board "X-20"
	141810147	Relay Circuit Board Assembly

RECTIFIER CIRCUIT BOARD

Schematic Location	Part No.	Description
CAPACITORS		
C903,904 } C906,907 }	440100985	Ceramic, 0.01 mfd, 250V
C905,908	431100894	Oil, 0.1 mfd ±20%, 400V
DIODES		
D903,904	300919010	ESACO2-N, Rectifier

Schematic Location	Part No.	Description
D905,906	300919009	ESACO2-C, Rectifier
	140800145	Printed Circuit Board "B-13"
	141810145	Rectifier Circuit Board Assembly

Roland Electronics Co., Ltd.	Main Office:	1-36-8 Ohokayama, Meguro-ku, Tokyo, Japan
	Chofu Plant:	3-60-3 Kamiishihara, Chofu-shi, Tokyo, Japan
Rotel Electronics Co., Ltd.	Office & Plant:	310, Sec. 5, Nanking E. Road, Taipei, Taiwan
Rotel of America Inc.	Main Office:	2642 Central Ave., Yonkers, New York 10710, U.S.A.