

SERVICE MANUAL

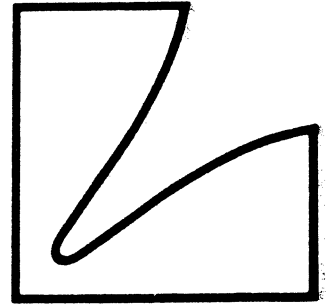

Preamplifier **C-120A**

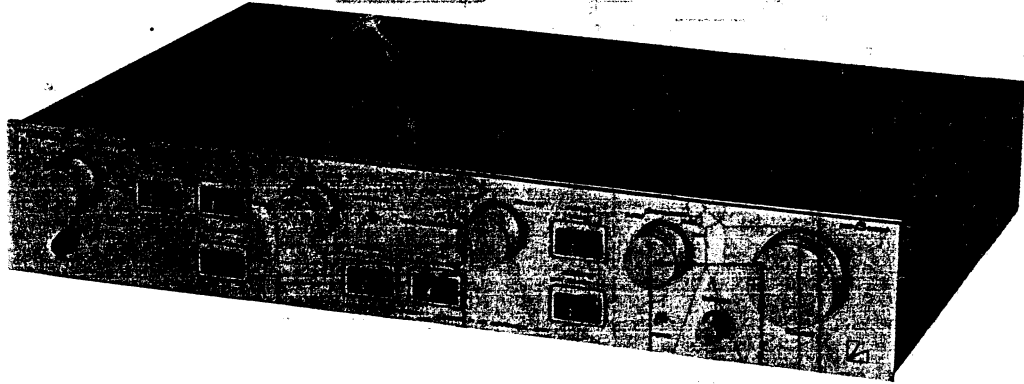
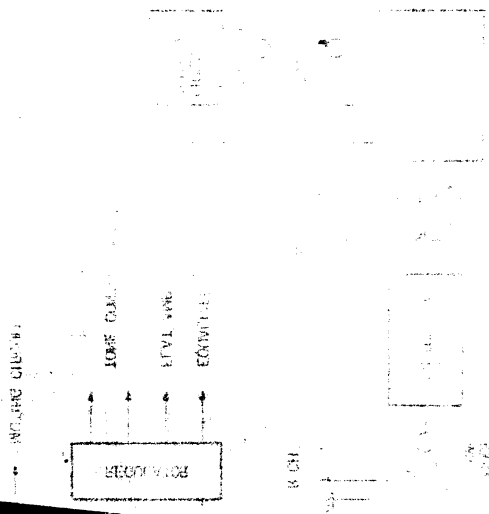

BLOCK DIAGRAM

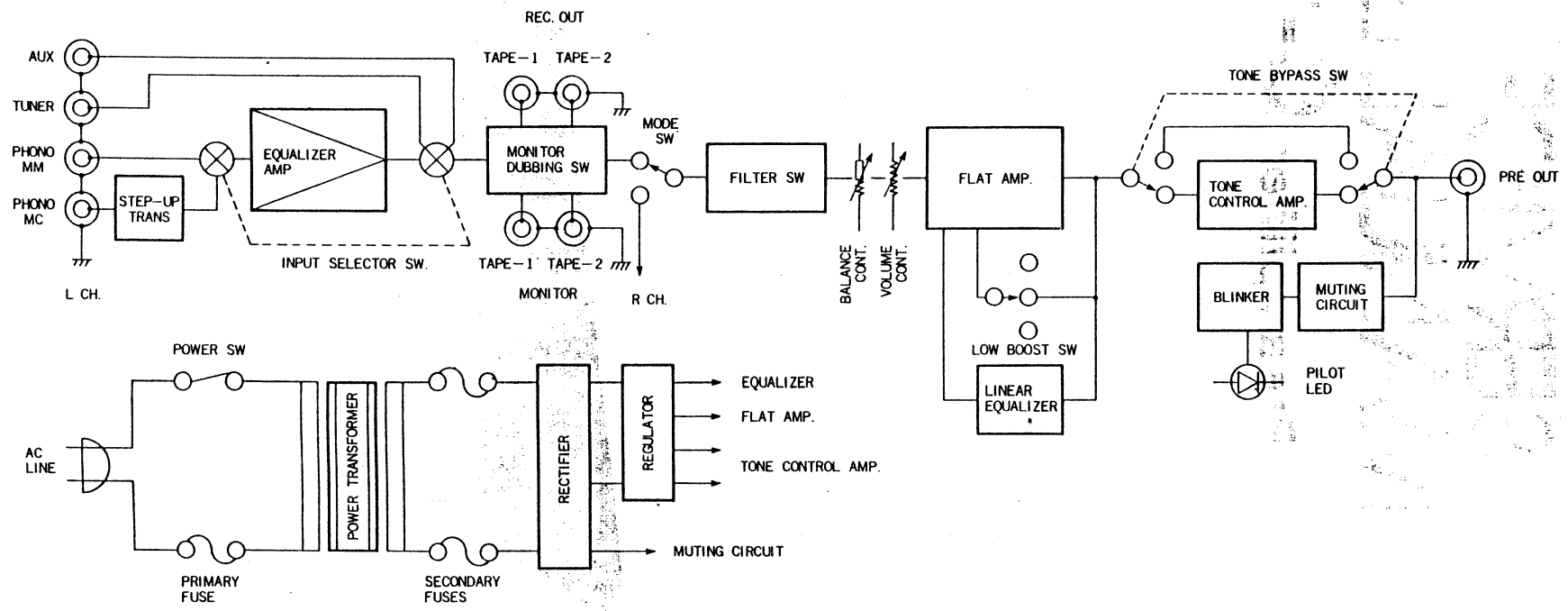

ALIGNMENT PROCEDURE

- (1) Turn ON the POWER SWITCH and wait 3 minutes for warm-up.
- (2) Set the VOLUME CONTROL at the minimum.
- (3) Adjust the VR201 to get 0 volt at the TP-1 on the PB5116.
- (4) Adjust the VR201 to get 0 Volt at the TP-2 on the PB5116.

REPRACEMENT PARTS - - - - (Cosmetics)

FRONT VIEW

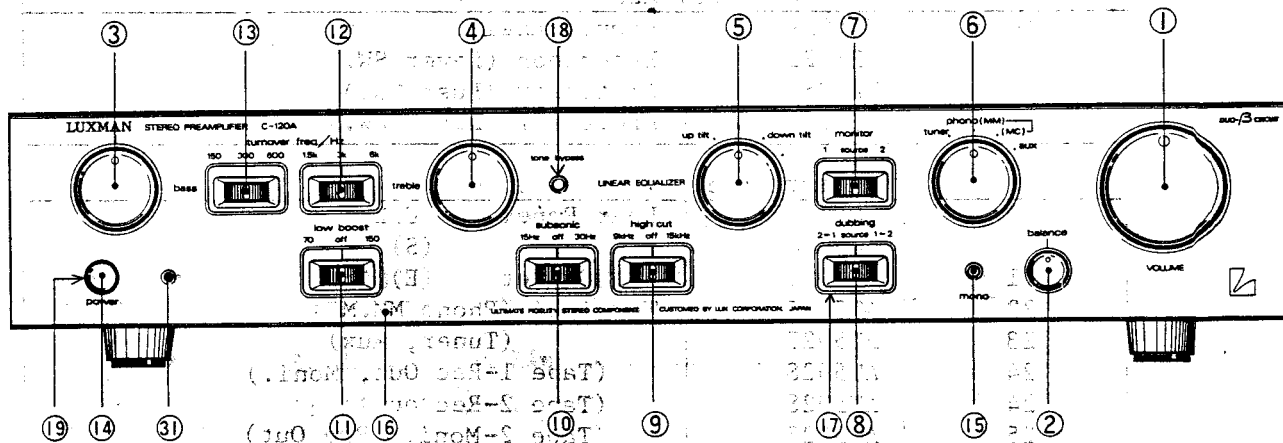

REAR VIEW

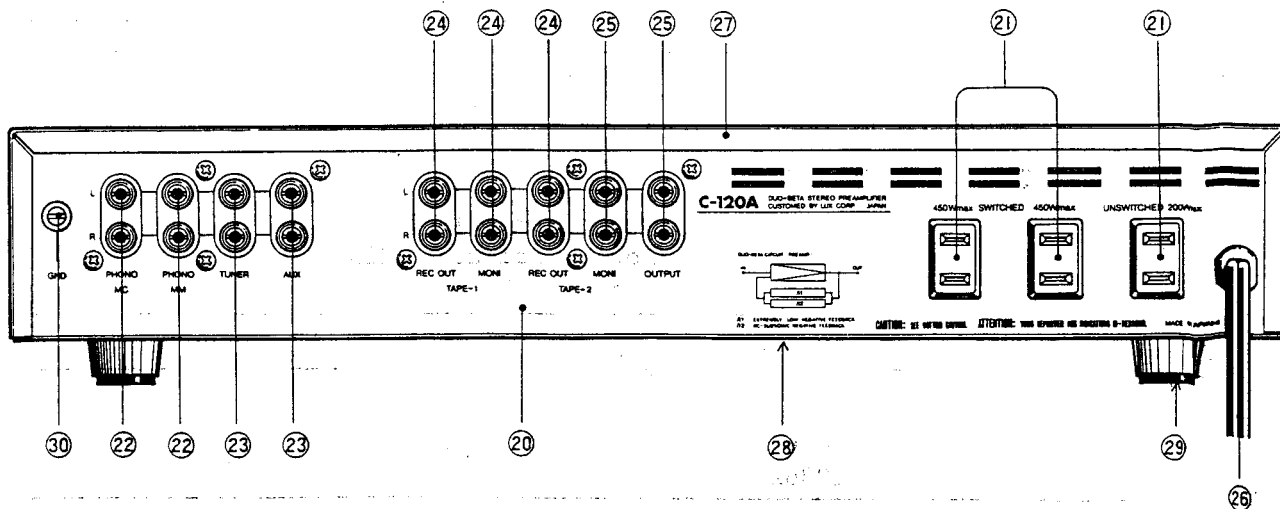

Parts List...(Cosmetic)

REF. NO.	STOCK NO.	DESCRIPTION
< Knob >		
1	WH1105	Volume Control (E, S)
	WH1100	(U)
2	WH1107	Balance Control (E, S)
	WH1102	(U)
3	WH1106	Tone Control (Base) (E, S)
	WH1101	(U)
4	WH1106	Tone Control (Treble) (E, S)
	WH1101	(U)
5	WH1106	Linear Equalizer (E, S)
	WH1101	(U)
6	WH1106	Input Selector (E, S)
	WH1101	(U)
7 ~ 13	WJ3009	Lever Switch (E, S)
7 ~ 13	WJ1121	(U)
14	WJ1133	Power Switch
15	WJ1134P	Mode Mono/Stereo
< Front Panel Ass'y >		
16	WA5059	Front Panel
17	WD1122	Escucheon (Lever SW.)
18	WE1086	Protector (Push SW.)
19	WE1089	Protector (Power SW.)
< Rear Panel >		
20	UC5025	Rear Panel (U, E)
	UC5028	(S)
21	AC0051	AC, Outlet (E)
22	AT5027	Terminal (Phono MM, MC)
23	AT5027	(Tuner, Aux)
24	AT5028	(Tape 1-Rec Out, Moni.)
24	AT5028	(Tape 2-Rec out)
25	AT5027	(Tape 2-Moni., Pre Out)
< Power Cord >		
26	BK0023	240V. Only
26	BK0022	220V. Only (Class-1)
26	BK0018	120V. Only (USA, Canada)
27	UG1024	Bonnet (E, S)
28	UE1104	Bottom Plate (E, S)
29	WN0007	Foot (E, S)
27'	WB5006	Wooden Case (U)
29'	WN1019	Foot (U)
30	SG0048	GND. Terminal
31	TD0196	Power Indicator (LED)
	AS0187	Socket, LED
< Packing Material >		
	XA5103B	Carton (E, S)
	XA5102A	(U)
	XB1036B	Pad (E, S)
	XB1036A	(U)

REF. NO.	STOCK NO.	DESCRIPTION
< Variable Resistor >		
VR001AB	RV5065	Balance Control
VR002AB	RV5064	Volume Control
VR003AB	RV5063	Treble Control
VR004AB	RV5062	Bass Control
< Switch >		
SW001	SR5045	Input Selector
SW002	SL0051	Tape Monitor
SW003	SL0051	Tape Dubbing
SW004	SP5044	Mode, Mono/Stereo
SW005	SL0050	Subsonic
SW006	SL0050	High Cut
SW007	SL0050	Low Boost
SW008	SR5046	Linear Equalizer
SW009	SP5043	Tone Bypass
SW010	SL0050	Treble Turn Over Sel.
SW011	SL0050	Bass Turn Over Sel.
	UZ5027	Shaft For SW001, 8
< Power Switch >		
	SP0090	SDG5P502-5A (E)
	SP0090	SDG5P502-5A (S)
	SP0063	SDG5P-TV5CSA (U)
< Power Transformer >		
	PT5089	P2440 (100 ~ 240V) (E)
	PT5088	P2439 (220V or 240V) (S)
	PT5087	P2438 (120 V) (U)

E: 220V (With Line Voltage selector)

S: 220V or 240V

U: 120V only (U.S.A. and Canada)

Replacement Parts List ... (P.C.B.)

REMARKS

Capacitor: My...Mylar, El...Electrolitic, St...Styrol, Ce...Ceramic
 Mi...Mica, Ta...Tantalum, Lp...Line pass(AC Cap.)
 Tm...Trimmer, Ac...AC Capacitor, Fi...Film Cap.
 Resistor: Rd...Carbon, Rc...Cement, Rm...Metal Film, Rf...Flame proof
 Ro...Oxid Metal,
 +5%,0.25W, unless specified otherwise.

< CAPACITOR >

SYMBOL NO.	PARTS NO.	DESCRIPTION			
C001	CU0073	CAPACITOR	0.047 μ F	120WV	Lp
C001	CM0060	CAPACITOR	47pF	500WV	Mi
C002	CU0041	CAPACITOR	0.022 μ F	250WV	Lp
C002	CM0060	CAPACITOR	47pF	500WV	Mi
C003	CU0041	CAPACITOR	0.022 μ F	250WV	Lp
C004	CU0073	CAPACITOR	0.047 μ F	120WV	Lp
C005	CU0073	CAPACITOR	0.047 μ F	120WV	Lp
C006	CU0041	CAPACITOR	0.022 μ F	250WV	Lp
C007	CU0041	CAPACITOR	0.022 μ F	250WV	Lp
C008	CU0041	CAPACITOR	0.022 μ F	250WV	Lp
C009	CU0041	CAPACITOR	0.022 μ F	250WV	Lp
C101	CM5004	CAPACITOR	56pF	500WV	Mi
C102	CM5004	CAPACITOR	56pF	500WV	Mi
C103	CQ0258	CAPACITOR	6800pF	50WV	St
C104	CQ0258	CAPACITOR	6800pF	50WV	St
C105	CQ0068	CAPACITOR	1800pF	50WV	St
C106	CQ0068	CAPACITOR	1800pF	50WV	St
C107	CQ0267	CAPACITOR	100pF	50WV	St
C108	CQ0267	CAPACITOR	100pF	50WV	St
C109	CQ0284	CAPACITOR	6400pF	50WV	St
C110	CQ0284	CAPACITOR	6400pF	50WV	St
C111	CE2041	CAPACITOR	22 μ F	50WV	El
C112	CE2041	CAPACITOR	22 μ F	50WV	El
C113	CQ0267	CAPACITOR	100pF	50WV	St
C114	CQ0267	CAPACITOR	100pF	50WV	St
C115	CE2040	CAPACITOR	10pF	50WV	Ce
C116	CE2040	CAPACITOR	10 μ F	50WV	El
C117	CQ0005	CAPACITOR	0.1 μ F	50WV	My
C119	CQ0005	CAPACITOR	0.1 μ F	50WV	My
C121	CE0857	CAPACITOR	47 μ F	50WV	El
C122	CE0857	CAPACITOR	47 μ F	50WV	El
C123	CE0857	CAPACITOR	47 μ F	50WV	El
C124	CE0857	CAPACITOR	47 μ F	50WV	El
C125	CQ0120	CAPACITOR	0.47 μ F	250WV	My
C127	CQ0120	CAPACITOR	0.47 μ F	250WV	My
C129	CQ0120	CAPACITOR	0.47 μ F	250WV	My
C130	CQ0120	CAPACITOR	0.47 μ F	250WV	My
C201	CM0060	CAPACITOR	47pF	500WV	Mi
C202	CM0060	CAPACITOR	47pF	500WV	Mi
C203	CQ0320	CAPACITOR	3900pF	50WV	St
C204	CQ0320	CAPACITOR	3900pF	50WV	St
C205	CM0040	CAPACITOR	5pF	500WV	Mi
C206	CM0040	CAPACITOR	5pF	500WV	Mi
C207	CQ0245	CAPACITOR	0.039 μ F	50WV	My
C208	CQ0245	CAPACITOR	0.039 μ F	50WV	My
C209	CQ0245	CAPACITOR	0.039 μ F	50WV	My
C210	CQ0245	CAPACITOR	0.039 μ F	50WV	My
C211	CE2040	CAPACITOR	10 μ F	50WV	El
C212	CE2040	CAPACITOR	10 μ F	50WV	El

C213	CQ0267	CAPACITOR	100pF	50WV	St
C214	CQ0267	CAPACITOR	100pF	50WV	St
C215	CQ0016	CAPACITOR	0.01μF	50WV	My
C215	CQ0238	CAPACITOR	0.01μF	50WV	My ADD.
C216	CQ0016	CAPACITOR	0.01μF	50WV	My

P.C. BOARD
PB-5116

A40047
A40025

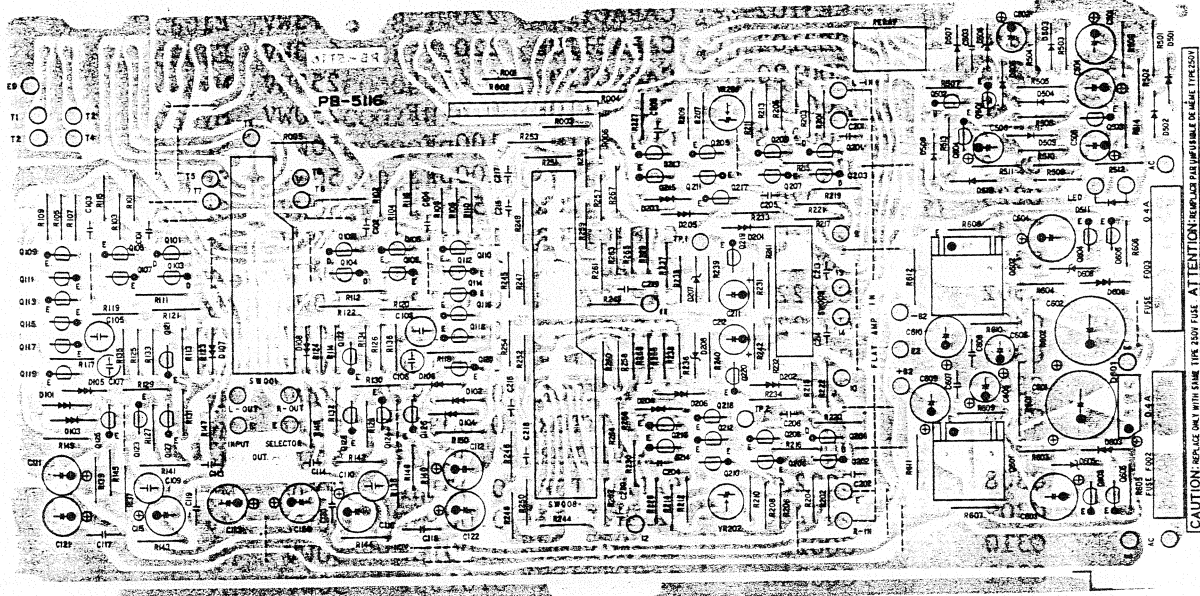

PB-5117...1

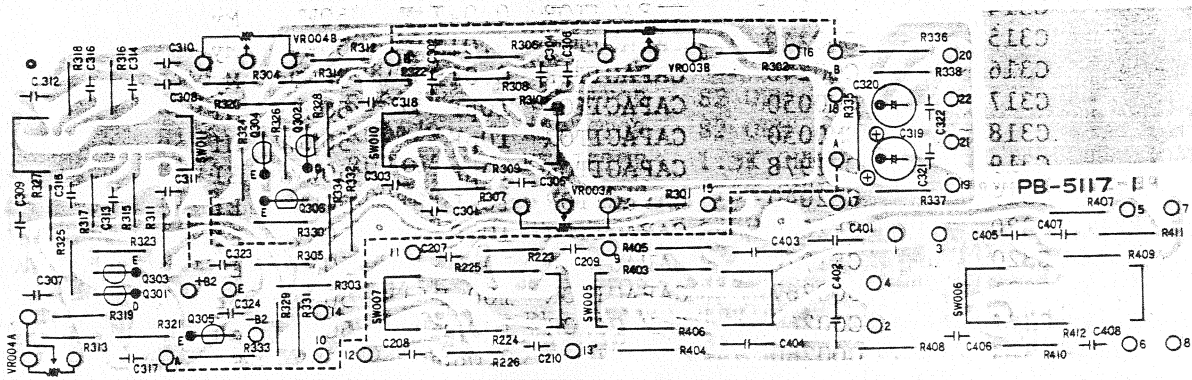

PB-5117...2

PB-5117...3

PB-5117 2

PB-5117 3

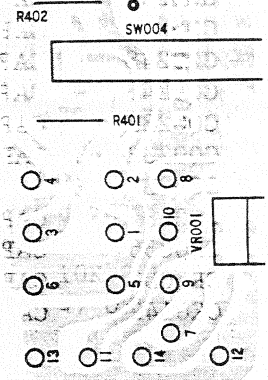
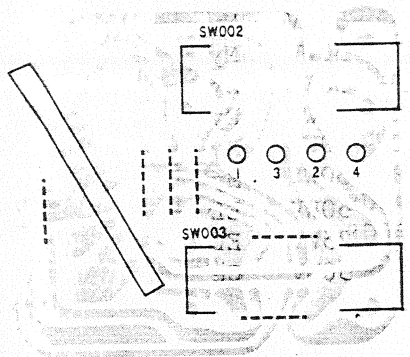

SYMBOL NO.	PARTS NO.	DESCRIPTION
R130	RD0482	RESISTOR 47 OHM
R131	RD0477	RESISTOR 120 OHM
R132	RD0477	RESISTOR 120 OHM
R133	RD0442	RESISTOR 100K OHM
R134	RD0442	RESISTOR 100K OHM
R135	RD0447	RESISTOR 39K OHM
R136	RD0447	RESISTOR 39K OHM
R137	RD0434	RESISTOR 470K OHM
R138	RD0434	RESISTOR 470K OHM
R139	RD2540	RESISTOR 18 OHM 0.5W Rd
R140	RD2540	RESISTOR 18 OHM 0.5W Rd
R141	RD2540	RESISTOR 18 OHM 0.5W Rd
R142	RD2540	RESISTOR 18 OHM 0.5W Rd
R143	RD2558	RESISTOR 100 OHM 0.5W Rd
R144	RD2558	RESISTOR 100 OHM 0.5W Rd
R145	RD0443	RESISTOR 82K OHM
R146	RD0443	RESISTOR 82K OHM
R147	RD0438	RESISTOR 220K OHM
R148	RD0438	RESISTOR 220K OHM
R149	RD0444	RESISTOR 68K OHM
R150	RD0444	RESISTOR 68K OHM
R201	RD0468	RESISTOR 680 OHM
R202	RD0468	RESISTOR 680 OHM
R203	RD0430	RESISTOR 1M OHM
R204	RD0430	RESISTOR 1M OHM
R205	RD0448	RESISTOR 33K OHM
R206	RD0448	RESISTOR 33K OHM
R207	RD0479	RESISTOR 82 OHM
R208	RD0479	RESISTOR 82 OHM
R209	RD0482	RESISTOR 47 OHM
R210	RD0482	RESISTOR 47 OHM
R211	RD0482	RESISTOR 47 OHM
R212	RD0482	RESISTOR 47 OHM
R213	RD0479	RESISTOR 82 OHM
R214	RD0479	RESISTOR 82 OHM
R215	RD0451	RESISTOR 18K OHM
R216	RD0451	RESISTOR 18K OHM
R217	RD2598	RESISTOR 4.7K OHM 0.5W Rd
R218	RD0458	RESISTOR 4.7K OHM
R218	RD2598	RESISTOR 4.7K OHM 0.5W Rd ADD.
R219	RD0458	RESISTOR 4.7K OHM
R221	RD0453	RESISTOR 12K OHM
R222	RD0453	RESISTOR 12K OHM
R223	RB0410	RESISTOR 39K OHM
R224	RB0410	RESISTOR 39K OHM
R225	RB0452	RESISTOR 2.2M OHM
R226	RB0452	RESISTOR 2.2M OHM
R227	RD0465	RESISTOR 1.2K OHM
R228	RD0465	RESISTOR 1.2K OHM
R229	RD0451	RESISTOR 18K OHM
R230	RD0451	RESISTOR 18K OHM
R231	RD0453	RESISTOR 12K OHM
R232	RD0453	RESISTOR 12K OHM
R233	RD0480	RESISTOR 68 OHM
R234	RD0480	RESISTOR 68 OHM

SYMBOL NO.	PARTS NO.	DESCRIPTION
C504	CE0842	CAPACITOR 47μF 35WV E1
C505	CE0839	CAPACITOR 10μF 35WV E1
C506	CE0839	CAPACITOR 10μF 35WV E1
C601	CE0869	CAPACITOR 470μF 63WV E1
C602	CE0869	CAPACITOR 470μF 63WV E1
C603	CE0859	CAPACITOR 220μF 50WV E1
C604	CE0859	CAPACITOR 220μF 50WV E1
C605	CE0857	CAPACITOR 47μF 50WV E1
C606	CE0857	CAPACITOR 47μF 50WV E1
C607	CQ0007	CAPACITOR 0.068μF 50WV My
C607	CQ0248	CAPACITOR 0.1μF 50WV My
C608	CQ0007	CAPACITOR 0.068μF 50WV My
C608	CQ0248	CAPACITOR 0.1μF 50WV My
C609	CE0843	CAPACITOR 100μF 35WV E1
C610	CE0843	CAPACITOR 100μF 35WV "

< RESISTOR >

R001	RD0430	RESISTOR 1M OHM
R002	RD0430	RESISTOR 1M OHM
R003	RD0430	RESISTOR 1M OHM
R004	RD0430	RESISTOR 1M OHM
R101	RD0446	RESISTOR 47K OHM
R102	RD0446	RESISTOR 47K OHM
R103	RD0448	RESISTOR 33K OHM
R104	RD0448	RESISTOR 33K OHM
R105	RD0479	RESISTOR 82 OHM
R106	RD0479	RESISTOR 82 OHM
R107	RD0464	RESISTOR 1.5K OHM
R108	RD0464	RESISTOR 1.5K OHM
R109	RD0479	RESISTOR 82 OHM
R110	RD0479	RESISTOR 82 OHM
R111	RD0451	RESISTOR 18K OHM
R112	RD0451	RESISTOR 18K OHM
R113	RD2610	RESISTOR 15K OHM
R114	RD2610	RESISTOR 15K OHM
R115	RD0489	RESISTOR 10 OHM
R116	RD0489	RESISTOR 10 OHM
R117	RD0482	RESISTOR 47 OHM
R118	RD0482	RESISTOR 47 OHM
R119	RD0468	RESISTOR 680 OHM
R120	RD0468	RESISTOR 680 OHM
R121	RD2580	RESISTOR 820 OHM 0.5W Rd
R122	RD2580	RESISTOR 820 OHM 0.5W Rd
R123	RD0447	RESISTOR 39K OHM
R124	RD0447	RESISTOR 39K OHM
R125	RD0455	RESISTOR 8.2K OHM
R126	RD0455	RESISTOR 8.2K OHM
R127	RD0454	RESISTOR 10K OHM
R128	RD0454	RESISTOR 10K OHM
R129	RD0482	RESISTOR 47 OHM

SYMBOL NO.	PARTS NO.	DESCRIPTION			
R319	RB0384	RESISTOR	3.3K OHM		
R320	RB0384	RESISTOR	3.3K OHM		
R321	RB0452	RESISTOR	2.2M OHM		
R322	RB0452	RESISTOR	2.2M OHM		
R323	RB0404	RESISTOR	22K OHM		
R324	RB0404	RESISTOR	22K OHM		
R325	RB0382	RESISTOR	2.7K OHM		
R326	RB0382	RESISTOR	2.7K OHM		
R327	RB0364	RESISTOR	470 OHM		
R328	RB0364	RESISTOR	470 OHM		
R329	RB0382	RESISTOR	2.7K OHM		
R330	RB0382	RESISTOR	2.7K OHM		
R331	RB0400	RESISTOR	15K OHM		
R332	RB0400	RESISTOR	15K OHM		
R333	RD2596	RESISTOR	3.9K OHM	0.5W	Rd
R334	RD2596	RESISTOR	3.9K OHM	0.5W	Rd
R335	RD2576	RESISTOR	560 OHM	0.5W	Rd
R336	RD2576	RESISTOR	560 OHM	0.5W	Rd
R337	RB0414	RESISTOR	56K OHM		
R338	RB0414	RESISTOR	56K OHM		
R401	RB0396	RESISTOR	10K OHM		
R402	RB0396	RESISTOR	10K OHM		
R403	RB0452	RESISTOR	2.2M OHM		
R405	RB0452	RESISTOR	2.2M OHM		
R406	RB0452	RESISTOR	2.2M OHM		
R407	RB0382	RESISTOR	2.7K OHM		
R408	RB0382	RESISTOR	2.7K OHM		
R409	RB0452	RESISTOR	2.2M OHM		
R410	RB0452	RESISTOR	2.2M OHM		
R411	RB0452	RESISTOR	2.2M OHM		
R412	RB0452	RESISTOR	2.2M OHM		
R501	RS5036	RESISTOR	180 OHM	1W	Ro
R502	RD0456	RESISTOR	6.8K OHM		
R503	RD2158	RESISTOR	1.5M OHM		
R504	RD0442	RESISTOR	100K OHM		
R505	RD0434	RESISTOR	470K OHM		
R506	RD0460	RESISTOR	3.3K OHM		
R507	RD0460	RESISTOR	3.3K OHM		
R508	RS2520	RESISTOR	470 OHM	0.5W	Ro
R509	RD2125	RESISTOR	62K OHM		
R510	RD2125	RESISTOR	62K OHM		
R511	RD0465	RESISTOR	1.2K OHM		
R512	RD0430	RESISTOR	1M OHM		
R513	RD0430	RESISTOR	1M OHM		
R514	RS2524	RESISTOR	1K OHM	0.5W	Rf
R601	RS5042	RESISTOR	4.7K OHM	2W	Ro
R602	RS5042	RESISTOR	4.7K OHM	2W	Ro
R603	RD0447	RESISTOR	39K OHM		
R604	RD0447	RESISTOR	39K OHM		
R605	RD0477	RESISTOR	120 OHM		
R606	RD0477	RESISTOR	120 OHM		
R607	RD0470	RESISTOR	470 OHM		
R608	RD0470	RESISTOR	470 OHM		
R609	RD2630	RESISTOR	100K OHM	0.5W	Rd
R610	RD2630	RESISTOR	100K OHM	0.5W	Rd
R611	RS2516	RESISTOR	220 OHM	0.5W	Ro
R612	RS2518	RESISTOR	330 OHM	0.5W	Ro

SYMBOL NO.	PARTS NO.	DESCRIPTION			
R235	RD0450	RESISTOR	22K OHM		
R236	RD0450	RESISTOR	22K OHM		
R237	RD0474	RESISTOR	220 OHM		
R238	RD0474	RESISTOR	220 OHM		
R239	RD2558	RESISTOR	100 OHM	0.5W	Rd
R240	RD2558	RESISTOR	100 OHM	0.5W	Rd
R241	RD0438	RESISTOR	220K OHM		
R242	RD0438	RESISTOR	220K OHM		
R243	RD0452	RESISTOR	15K OHM		
R244	RD0452	RESISTOR	15K OHM		
R245	RD0454	RESISTOR	10K OHM		
R246	RD0454	RESISTOR	10K OHM		
R247	RD0447	RESISTOR	39K OHM		
R248	RD0447	RESISTOR	39K OHM		
R249	RD0430	RESISTOR	1M OHM		
R250	RD0430	RESISTOR	1M OHM		
R251	RD0451	RESISTOR	18K OHM		
R252	RD0451	RESISTOR	18K OHM		
R253	RD0450	RESISTOR	22K OHM		
R254	RD0450	RESISTOR	22K OHM		
R255	RD0453	RESISTOR	12K OHM		
R256	RD0453	RESISTOR	12K OHM		
R257	RD0449	RESISTOR	27K OHM		
R258	RD0449	RESISTOR	27K OHM		
R259	RD0434	RESISTOR	470K OHM		
R260	RD0434	RESISTOR	470K OHM		
R261	RD2170	RESISTOR	4.7M OHM		
R262	RD2170	RESISTOR	4.7M OHM		
R263	RD0449	RESISTOR	27K OHM		
R264	RD0449	RESISTOR	27K OHM		
R265	RD0455	RESISTOR	8.2K OHM		
R266	RD0455	RESISTOR	8.2K OHM		
R267	RD0459	RESISTOR	3.9K OHM		
R268	RD0459	RESISTOR	3.9K OHM		
R269	RD0443	RESISTOR	82K OHM		
R270	RD0443	RESISTOR	82K OHM		
R271	RD0440	RESISTOR	150K OHM		
R272	RD0440	RESISTOR	150K OHM		
R301	RB0376	RESISTOR	1.5K OHM		
R302	RB0376	RESISTOR	1.5K OHM		
R303	RB0402	RESISTOR	18K OHM		
R303	RB0402	RESISTOR	18K OHM		
R305	RB0376	RESISTOR	1.5K OHM		
R306	RB0376	RESISTOR	1.5K OHM		
R307	RB0452	RESISTOR	2.2M OHM		
R308	RB0452	RESISTOR	2.2M OHM		
R309	RB0452	RESISTOR	2.2M OHM		
R310	RB0452	RESISTOR	2.2M OHM		
R311	RB0384	RESISTOR	3.3K OHM		
R312	RB0384	RESISTOR	3.3K OHM		
R313	RB0402	RESISTOR	18K OHM		
R314	RB0402	RESISTOR	18K OHM		
R315	RB0452	RESISTOR	2.2M OHM		
R316	RB0452	RESISTOR	2.2M OHM		
R317	RB0452	RESISTOR	2.2M OHM		
R318	RB0452	RESISTOR	2.2M OHM		

SYMBOL NO.	PARTS NO.	DESCRIPTION
Q502	TR5004	TRANSISTOR 2SC2240
Q503	TR5004	TRANSISTOR 2SC2240
Q504	TR5004	TRANSISTOR 2SC2240
Q601	TR0177	TRANSISTOR 2SD525
Q602	TR0176	TRANSISTOR 2SB595
Q603	TR5004	TRANSISTOR 2SC2240
Q604	TR5005	TRANSISTOR 2SA970
Q605	TR5005	TRANSISTOR 2SA970
Q606	TR5004	TRANSISTOR 2SC2240

DIODE

D101	TV0030	VARISTOR KB265C4
D102	TV0030	VARISTOR KB265C4
D103	TV0030	VARISTOR KB265C4
D104	TV0030	VARISTOR KB265C4
D105	TV0030	VARISTOR KB265C4
D106	TV0030	VARISTOR KB265C4
D107	TV0030	VARISTOR KB265C4
D108	TV0030	VARISTOR KB265C4
D201	TV0030	VARISTOR KB265C4
D202	TV0030	VARISTOR KB265C4
D203	TV0030	VARISTOR KB265C4
D204	TV0030	VARISTOR KB265C4
D205	TV0030	VARISTOR KB265C4
D206	TV0030	VARISTOR KB265C4
D207	TD5023	DIODE ZENER WZ-040 4V
D208	TD5023	DIODE ZENER WZ-040 4V
D501	TD0002	DIODE IN4002
D502	TD0002	DIODE IN4002
D503	TD0132	DIODE IS2472
D504	TD0132	DIODE IS2472
D505	TD0132	DIODE IS2472
D506	TD0027	DIODE ZENER WZ120 12V
D507	TD0002	DIODE IN4002
D508	TD0018	DIODE GE IK188FM-1
D509	TD0132	DIODE IS2472
D510	TD0132	DIODE IS2472
D511	TD0196	DIODE LED SLR-30UR
D601	TD0138	DIODE 1B4B41
D603	TV0030	VARISTOR KB265C4
D604	TV0030	VARISTOR KB265C4
D605	TD0183	DIODE ZENER WZ-340 34V
D606	TD0183	DIODE ZENER WZ-340 34V

FUSE

F;002	BF0110	FUSE 125V 0.4A JAPAN
F;003	BF0110	FUSE 125V 0.4A JAPAN
F;003	BF0074	FUSE 250V 0.5A U.S.A., Canada
F001	BF0202	FUSE 250V 0.2A(T) SEMKO
F001	BF0110	FUSE 125V 0.4A JAPAN
F001	BF0073	FUSE 250V 0.4A U.S.A., Canada
F002	BF0204	FUSE 250V 0.315A(T) SEMKO
F002	BF0074	FUSE 250V 0.5A U.S.A., Canada
F003	BF0204	FUSE 250V 0.315A(T) AEMKO

Relay

AY0025 R2-24
AY0047

< TRANSISTOR >

SYMBOL NO.	PARTS NO.	DESCRIPTION
Q101	TF5005	FET 2SK240-BL-PAIR
Q102	TF5005	FET 2SK240-BL-PAIR
Q103	TF5005	FET 2SK240-BL-PAIR
Q104	TF5005	FET 2SK240-BL-PAIR
Q105	TR5004	TRANSISTOR 2SC2240
Q106	TR5004	TRANSISTOR 2SC2240
Q107	TR5004	TRANSISTOR 2SC2240
Q108	TR5004	TRANSISTOR 2SC2240
Q109	TR5005	TRANSISTOR 2SA970
Q110	TR5005	TRANSISTOR 2SA970
Q111	TR5005	TRANSISTOR 2SA970
Q112	TR5005	TRANSISTOR 2SA970
Q113	TR5005	TRANSISTOR 2SA970
Q114	TR5005	TRANSISTOR 2SA970
Q115	TR5005	TRANSISTOR 2SA970
Q116	TR5005	TRANSISTOR 2SA970
Q117	TR5005	TRANSISTOR 2SA970
Q119	TR0237	TRANSISTOR 2SA949
Q120	TR0237	TRANSISTOR 2SA949
Q121	TR0236	TRANSISTOR 2SC2229
Q122	TR0236	TRANSISTOR 2SC2229
Q127	TR5004	TRANSISTOR 2SC2240
Q128	TR5004	TRANSISTOR 2SC2240
Q201	TF5005	FET 2SK240-BL-PAIR
Q202	TF5005	FET 2SK240-BL-PAIR
Q203	TF5005	FET 2SK240-BL-PAIR
Q204	TF5005	FET 2SK240-BL-PAIR
Q205	TR5004	TRANSISTOR 2SC2240
Q206	TR5004	TRANSISTOR 2SC2240
Q207	TR5004	TRANSISTOR 2SC2240
Q208	TR5004	TRANSISTOR 2SC2240
Q209	TR5005	TRANSISTOR 2SA970
Q210	TR5005	TRANSISTOR 2SA970
Q211	TR5005	TRANSISTOR 2SA970
Q212	TR5005	TRANSISTOR 2SA970
Q213	TR5005	TRANSISTOR 2SA970
Q214	TR5005	TRANSISTOR 2SA970
Q215	TR5005	TRANSISTOR 2SA970
Q216	TR5005	TRANSISTOR 2SA970
Q217	TR0237	TRANSISTOR 2SA949
Q218	TR0237	TRANSISTOR 2SA949
Q219	TR0236	TRANSISTOR 2SC2229
Q220	TR0236	TRANSISTOR 2SC2229
Q221	TR5005	TRANSISTOR 2SA970
Q222	TR5005	TRANSISTOR 2SA970
Q301	TF0028	FET 2SK170-BL-PAIR
Q302	TF0028	FET 2SK170-BL-PAIR
Q303	TR0198	TRANSISTOR 2SC1815
Q304	TR0198	TRANSISTOR 2SC1815
Q305	TR0087	TRANSISTOR 2SA1015
Q306	TR0087	TRANSISTOR 2SA1015
Q501	TR5005	TRANSISTOR 2SA970

SPECIFICATIONS

Output Voltage:	Pre. Out;	typical 1V, max. 18V
	Rec. Out;	typical 130mV, max. 18V
Total Harmonic Distortion:	phono MM;	no more than 0.007%
	(Rec. Out. 3V. 20 - 20 kHz)	
	aux, tuner;	no more than 0.007%
	(Pre. Out. 3V. 20 - 20kHz)	
Frequency Response:	phono;	20Hz - 20,000Hz ± 0.3 dB (Rec. Out)
	aux, tuner;	10Hz - 80,000Hz -0.5 dB
Signal-to-Noise Ratio:	phono MC;	74 dB
	(IHF-A weighted, input short-circuited)	
	phono MM;	88 dB (IHF-A weighted, 10mV input)
	aux, tuner;	100dB
	(IHF-A weighted, input short-circuited)	
Input Sensitivity: (Pre. Out; 1V)	phono MC;	200 μ V
	phono MM;	2.0mV
	aux, tuner;	130mV
Input Impedance:	phono MC;	390 ohms
	phono MM;	50K ohms
	aux, tuner;	60K ohms
	monitor;	60k ohms
Output Impedance:	Pre. Out;	100 ohms
	Rec. Out;	100 ohms
Phono Overload Voltage:	300 mV.	
Tone Control:	Bass Turnover Frequencies;	150Hz, 300Hz, & 600Hz
	Treble Turnover Frequencies;	1.5kHz, 3kHz & 6kHz
Linear Equalizer:	Up-tilt;	2 points
	Down-tilt;	2 points
Low Boost:	70Hz & 150Hz	(6dB max.)
Subsonic Filter:	15Hz & 30Hz	6dB/oct.
High Cut Filter:	9kHz & 15kHz	6dB/oct.
Additional Features:	Dual Tape Monitoring Circuit, Tape Dubbing Circuit, Built-in Step Up Transformer for MC cartridge, Tone Bypass Switch	
Power Consumption:	17W	
Dimensions:	metal cabinet	
	438(W) x 290(D) x 87(H) mm	
	(17-1/4" x 11-7/16" x 3-7/16")	
	wooden case	
	465(W) x 290(D) x 120(H) mm	
	(18-5/16" x 11-7/16" x 4-23/32")	
Weight:	metal cabinet	wooden case
	Net 5.5 kgs (12.1 lbs.)	Net 5.0 kgs (11.0 lbs.)
	Gross 6.7 kgs (14.7 lbs.)	Gross 6.2 kgs (13.6 lbs.)

Specifications and appearance design subject to change without notice.

LUX CORPORATION, JAPAN

1-1, 1-CHOME, SHINSENRI-NISHIMACHI, TOYONAKASHI,
OSAKA, JAPAN PHONE: 06-834-0004 TELEX: J53694