

CROWN[®]

SERVICE MANUAL



PS-400/POWER LINE FOUR AMPLIFIERS

CROWN INTERNATIONAL, INC. 1718 W. MISHAWAKA RD. ELKHART, INDIANA 46517

©Crown International, Inc.
K80078-7
5/90

The information furnished in this manual does not include all of the details of design, production, or variations of the equipment. It does not cover all the possible contingencies which may arise during operation, installation, or maintenance. Should special problems arise, or further information be desired, please contact the Crown International Customer Services Department.

Crown International
1718 W. Mishawaka Rd.
Elkhart, Indiana 46517
Ph: (219) 294-5571

WARNING

**TO PREVENT SHOCK OR
FIRE HAZARD DO NOT
EXPOSE TO RAIN OR
MOISTURE!**



TABLE OF CONTENTS

RVW Sec.	Review	
	I. Introduction	R-1
	II. Warranty	R-1
	III. Specifications	R-5
	IV. Panel Configuration	R-7
	V. Performance Graphs	
Section 6	Illustrated Parts List	
	6.1 General Information	6-1
	6.2 Standard and Special Parts	6-1
	6.3 Ordering Parts	6-1
	6.4 Shipment	6-1
	6.5 Terms	6-3
	6.6 Schematics/Parts Lists/Exploded View Drawings	
Section 7	Maintenance	
	7.1 Introduction	7-1
	7.2 Required Test Equipment	7-2
	7.3 Basic Troubleshooting	7-2
	7.4 Discharging Instructions	7-2
	7.5 Disassembly for Inspection, Service, Testing, Adjustment and Repairs	7-5
	7.6 Reassembly	7-5
	7.7 Electrical Checkout and Adjustment Procedures	7-5
	7.8 Troubleshooting Hints	7-8
	7.9 Voltage Conversion Chart	7-10
	7.10 Block Diagram Circuit Theory	

LIST OF ILLUSTRATIONS

Fig. RVW. 1	PS-400 Front Panel	R-5
Fig. RVW. 2	PS-400 Back Panel	R-5
Fig. RVW. 3	Power Line Four Front Panel	R-6
Fig. RVW. 4	Power Line Four Rear Panel	R-6
Fig. RVW. 5	Nominal Power Efficiency	R-7
Fig. RVW. 6	Nominal Frequency Response	R-7
Fig. RVW. 7	Nominal Phase Response	R-8
Fig. RVW. 8	Typical Damping Factor (8 ohms)	R-8
Fig. RVW. 9	Typical Output Impedance	R-9
Fig. RVW. 10	Nominal Noise Spectrum	R-9
Fig. RVW. 11	Harmonic Distortion	R-10
Fig. RVW. 12	Nominal Output Phase Angle	R-10
Fig. RVW. 13	Typical Crosstalk	R-11
Fig. RVW. 14	Low Frequency Interrupt Action	R-12
Fig. 6.1	PS-400 Schematic	6-3
Fig. 6.2	Power Line Four Schematic	6-4
Fig. 6.3	PS-400/Power Line Four Main Component Board Layout; P10026-6	6-5
Fig. 6.4	PS-400/Power Line Four Main Foil Board Layout; P10026-6	6-5
Fig. 6.5	PS-400/Power Line Four Control Module Component Board Layout; P 9983B7	6-7
Fig. 6.6	PS-400/Power Line Four Control Module Foil Board Layout; P 9983B7	6-7
Fig. 6.7	PS-400 Display Module Component Board Layout; P 9980B3	6-8
Fig. 6.8	PS-400 Display Module Foil Board Layout; P 9980B3	6-8
Fig. 6.9	PS-400/Power Line Four Output Module Component Board Layout; M20217-2	6-9
Fig. 6.10	PS-400/Power Line Four Output Module Foil Board Layout; M20217-2	6-9
Fig. 6.11	Power Line Four Display Module Component Board Layout; P 9987A0	6-11
Fig. 6.12	Power Line Four Display Module Foil Board Layout; P 9987A0	6-11
Fig. 6.13	PS-400/Power Line Four Front Chassis Assembly	6-15
Fig. 6.14	PS-400/Power Line Four Back Chassis Assembly	6-16
Fig. 6.15	PS-400 Internal Hard Wiring Diagram	6-17
Fig. 6.16	Power Line Four Internal Hard Wiring Diagram	6-18
Fig. 7.1	Thermal Transistor Voltage Table	7-6
Fig. 7.2	Clipped Waveform	7-7
Fig. 7.3	20KHz Sine Wave Response, 8 ohms	7-7
Fig. 7.4	10KHz Square Wave Response, 8 ohms	7-7
Fig. 7.5	Inductive Load Waveform, 2 ohms	7-7
Fig. 7.6	Mono Response Waveform	7-8
Fig. 7.7	Voltage Conversion Connect Drawing	7-9
Fig. 7.8	PS-400 Block Diagram	7-11
Fig. 7.9	Power Line Four Block Diagram	7-11



REVIEW SECTION

I. Introduction

This manual contains complete service information on the PS-400/Power Line Four. It is designed to be used in conjunction with the PS-400/Power Line Four Instruction Manual. However, some important information is duplicated in this Service Manual in case the Instruction Manual is not readily available.

NOTE: THE INFORMATION IN THIS MANUAL IS INTENDED FOR USE BY AN EXPERIENCED TECHNICIAN ONLY!

II. Warranty

As a Crown Warranty Service Station, you should be familiar with Crown warranty policies. Each Instruction Manual contains basic policies as related to the customer. However, under questionable circumstances, please contact the Technical Service Department or Director of Customer Service at: Crown International, Inc., 1718 W. Mishawaka Road, Elkhart, IN 46517.

III. PS-400 General Specifications

Hum and Noise (20Hz-20KHz): 112dB below rated output.

Phase Response: +0, -15 degrees DC-20KHz at 1 watt.

Input Impedance: 30K ohm, $\pm 20\%$.

Amplifier Output Protection: Short, mismatch, and open circuit proof. Limiting is instantaneous with no flyback pulses, thumps, cutout, etc. No premature limiting transients.

Overall Protection: AC line fused. Thermal switch in control logic protects against overheating caused by insufficient ventilation. Controlled slewing rate voltage amplifiers protect overall amplifier against RF burnouts. Input overload protection is furnished by internal resistance at inputs of amp.

Low Frequency Interrupt: Interrupts output drive (standby mode) with automatic sampling every four

seconds. Activates at DC outputs greater than 10V or low frequency outputs greater than 10V at 2Hz.

Turn-on: Four second delay with minimum thumps and no dangerous transients.

DC Output Offset (shorted input): 10 millivolts or less, internally adjustable to zero.

Power Supply: 1 kilowatt transformer with massive computer-grade filter capacitors storing over 48 joules of energy. Two regulated supplies for complete isolation and stability.

Power Requirements: Requires 50-400Hz AC with selectable taps for 100, 120, 200, 220 and 240V $\pm 10\%$ operation. Draws 40 watts or less on idle, 560 watts at 330 watts total output.

Heat Sinking: Massive black-anodized heat sinks are thermally joined with the chassis, thereby utilizing the entire amplifier as a heat sink. Optional forced air cooling available.

Chassis: All aluminum construction for maximum heat conduction and minimum weight.

Controls: Pushbutton on/off power switch. Independent Input Level controls. Rear panel Stereo/Mono slide switch.

Display: A pair of green LED's indicate Signal Presence. A pair of red LED's indicate the action of the IOC™ circuitry. An amber LED is used as a Power indicator.

Connectors: AC Line - three wire (grounded) male connector. Input - ¼ inch phone jacks; unbalanced, 3 terminal barrier block. Output - color coded dual binding posts on ¾ inch centers; 4 terminal barrier block. Output Monitor - ¼" stereo phone jack. Ground Selectivity - 2 lug terminal block with removable shorting strap. Accessory - 11 pin "octal" socket; accepts active or passive balanced input module or user options (pins include $\pm VCC$, two channel inputs, circuit ground and chassis ground).

Dimensions: 19 inch (48.3cm) standard rack mount, 7 inches (17.8cm) high, 10.125 inches (25.7cm) deep from mounting surface of front panel. Handles extend 2.38 inches (6cm) from front panel. Rectangular shape designed for convenient stacking capability.

Weight: Approximately 55 pounds (24.9kg) net weight.

Finish: Polyester vinyl coated aluminum front panel, zinc diecast handles.

IV. PS-400 Stereo Specifications

Output Power: 165 watts per channel minimum continuous average power (both channels operating) into an 8 ohm load over a bandwidth of 1Hz-20KHz at a rated RMS sum total harmonic distortion of 0.05% of the fundamental output voltage. 265 watts per channel minimum continuous average power (both channels operating) into a 4 ohm load over a bandwidth of 1Hz-20KHz at a rated RMS sum total harmonic distortion of 0.05% of the fundamental output voltage.

Frequency Response: ± 0.1 dB DC-20KHz at 1 watt into 8 ohms; ± 1 dB DC-100KHz.

1KHz Power: 180 watts continuous average power into 8 ohms, per channel, both channels operating, 0.1% total harmonic distortion.

Harmonic Distortion: Less than 0.001% from 20Hz-400Hz, and increasing linearly to 0.05% at 20KHz at 165 watts continuous average power per channel into 8 ohms.

I.M. Distortion (60Hz-7KHz 4:1): Less than 0.05% from 0.01 watts to 0.25 watts and less than 0.01% from 0.25 watts to 165 watts into 8 ohms, per channel.

Slewing Rate: 16 volts per microsecond (slewing rate is the maximum value of the first derivative of the output signal, or the maximum slope of the output signal).

Damping Factor: Greater than 400, DC-400Hz into 8 ohms.

Output Impedance: Less than 7 milliohms in series with less than 3 microhenries.

Load Impedance: Rated for 4 and 8 ohm usage; safely drives any load including completely reactive loads.

Voltage Gain: 20.6 $\pm 2\%$ or 26.3 ± 0.3 dB at maximum gain.

Input Sensitivity: 1.76 volts $\pm 2\%$ for 165 watts into 8 ohms.

Output Signal: Unbalanced, dual channel (optional output transformer available for 70V line).

V. PS-400 Monaural Specifications

Output Power: 330 watts minimum continuous average power into a 16 ohm load over a bandwidth of 1Hz-20KHz at a rated RMS sum total harmonic distortion of 0.05% of the fundamental output voltage. 530 watts minimum continuous average power into an 8 ohm load over a bandwidth of 1Hz-20KHz at a rated RMS sum total harmonic distortion of 0.05% of the fundamental output voltage.

Frequency Response: ± 0.15 dB, DC-20KHz at 1 watt into 16 ohms; ± 1 dB, DC-60KHz at 1 watt into 16 ohms.

1KHz Power: 360 watts continuous average power into 16 ohms; 0.1% total harmonic distortion.

Harmonic Distortion: Less than 0.001% from 20Hz-400Hz and increasing linearly to 0.05% at 20KHz at 330 watts into 16 ohms.

I.M. Distortion: Less than 0.05% from 0.01 watts to 0.25 watts and less than 0.01% from 0.25 watts to 330 watts into 16 ohms, per channel.

Slewing Rate: 32 volts per microsecond.

Damping Factor: Greater than 400, DC-400Hz into 16 ohms.

Output Impedance: Less than 15 milliohms in series with less than 6 microhenries.

Load Impedance: Rated for 8 and 16 ohm usage; safely drives any load including completely reactive loads.

Voltage Gain: 41.2 $\pm 2\%$ or 32.3 ± 0.2 dB at maximum gain.

Input Sensitivity: 1.76 volts for 330 watts into 16 ohms.

Output Signal: Balanced, single channel.

VI. Power Line Four General Specifications

Hum and Noise (20Hz-20KHz): 112dB below rated output.

Phase Response: +0, -15 degrees 10-20KHz at 1 watt.

Input Impedance: 30K ohm, $\pm 20\%$.

Amplifier Output Protection: Short, mismatch, and open circuit proof. Limiting is instantaneous with no flyback pulses, thumps, cutout, etc. No premature limiting transients.

Overall Protection: AC line fused. Thermal switch in control logic protects against overheating caused by insufficient ventilation. Controlled slewing rate voltage amplifiers protect overall amplifier against RF burnouts. Input overload protection is furnished by internal resistance at inputs of amp.



Low Frequency Interrupt: Interrupts output drive (standby mode) with automatic sampling every four seconds. Activates at DC outputs greater than 10V or low frequency outputs greater than 10V at 2Hz.

Turn-on: Four second delay with minimum thumps and no dangerous transients.

DC Output Offset (shorted input): 10 millivolts or less, internally adjustable to zero.

Power Supply: 1 kilowatt transformer with massive computer-grade filter capacitors storing over 48 joules of energy. Two regulated supplies for complete isolation and stability.

Power Requirements: Requires 50-400Hz AC with selectable taps for 100, 120, 200, 220 and 240V $\pm 10\%$ operation. Draws 40 watts or less on idle, 560 watts at 330 watts total output.

Heat Sinking: Massive black-anodized heat sinks are thermally joined with the chassis, thereby utilizing the entire amplifier as a heat sink.

Chassis: All aluminum construction for maximum heat conduction and minimum weight.

Controls: Pushbutton on/off power switch. Independent Input Level controls. Rear panel Stereo/Mono slide switch.

Display: Three pair of LED's form a Frequency Analyzing Display. A pair of red LED's indicate the action of the IOC™ circuitry. An amber LED is used as a Power indicator.

Connectors: AC Line - two wire male connector. Input - standard pin jacks; unbalanced, Output - color coded dual binding posts on $\frac{3}{4}$ inch centers. Output Monitor - $\frac{1}{4}$ " stereo phone jack.

Dimensions: 19 inch (48.3cm) standard rack mount, 7 inches (17.8cm) high, 10.125 inches (25.7cm) deep from mounting surface of front panel. Handles extend 2.38 inches (6cm) from front panel.

Weight: Approximately 55 pounds (24.9kg) net weight.

Finish: Brushed and satinized aluminum front panel, zinc diecast handles.

VII. Power Line Four Stereo Specifications

Output Power: 165 watts per channel minimum RMS (both channels operating) into an 8 ohm load over a bandwidth of 20Hz-20KHz at a rated RMS sum total harmonic distortion of 0.05% of the fundamental output voltage. 265 watts per channel minimum RMS (both channels operating) into a 4 ohm load over a bandwidth of 20Hz-20KHz at a rated RMS sum total harmonic distortion of 0.05% of the fundamental output voltage.

Frequency Response: ± 0.1 dB 10-20KHz at 1 watt into 8 ohms; +0dB, -1.5dB 10Hz-100KHz.

1KHz Power: 180 watts RMS into 8 ohms, per channel, both channels operating, 0.1% total harmonic distortion.

Harmonic Distortion: Less than 0.001% from 20Hz-800Hz, and increasing linearly to .025% at 20KHz at 165 watts RMS per channel into 8 ohms.

I.M. Distortion (60Hz-7KHz 4:1): Less than 0.05% from 0.01 watts to 0.25 watts and less than 0.01% from 0.25 watts to 165 watts into 8 ohms, per channel.

Slewing Rate: 16 volts per microsecond (slewing rate is the maximum value of the first derivative of the output signal, or the maximum slope of the output signal).

Damping Factor: Greater than 400, DC-400Hz into 8 ohms.

Output Impedance: Less than 7 milliohms in series with less than 3 microhenries.

Load Impedance: Rated for 4 and 8 ohm usage; safely drives any load including completely reactive loads.

Voltage Gain: $20.6 \pm 2\%$ or 26.3 ± 0.3 dB at maximum gain.

Input Sensitivity: 1.76 volts $\pm 2\%$ for 165 watts into 8 ohms.

Output Signal: Unbalanced, dual channel.

VIII. Power Line Four Monaural Specifications

Output Power: 330 watts minimum RMS into a 16 ohm load over a bandwidth of 20Hz-20KHz at a rated RMS

sum total harmonic distortion of 0.05% of the fundamental output voltage. 530 watts minimum RMS into an 8 ohm load over a bandwidth of 20Hz-20KHz at a rated RMS sum total harmonic distortion of 0.05% of the fundamental output voltage.

Frequency Response: $\pm 0.15\text{dB}$, 10-20KHz at 1 watt into 16 ohms; $+0\text{dB}$, -1dB 10-60KHz at 1 watt into 16 ohms.

1KHz Power: 360 watts RMS into 16 ohms; 0.1% total harmonic distortion.

Harmonic Distortion: Less than 0.001% from 20Hz-800Hz and increasing linearly to .025% at 20KHz at 330 watts into 16 ohms.

I.M. Distortion : Less than 0.05% from 0.01 watts to 0.25 watts and less than 0.01% from 0.25 watts to 330 watts into 16 ohms, per channel.

Slewing Rate: 32 volts per microsecond.

Damping Factor: Greater than 400, DC-400Hz into 16 ohms.

Output Impedance: Less than 15 milliohms in series with less than 6 microhenries.

Load Impedance Rated for 8 and 16 ohm usage; safely drives any load including completely reactive loads.

Voltage Gain: $41.2 \pm 2\%$ or $32.3 \pm 0.2\text{dB}$ at maximum gain.

Input Sensitivity: 1.76 volts for 330 watts into 16 ohms.

Output Signal: Balanced, single channel.

IX. PS-MODX Specifications

Connectors: XLR type wired with pin 1 as ground, pin 2 as positive (+) and pin 3 as negative (-). Also, three terminal barrier block.

Signal to Noise: -110dB (from rated output of PS-400).

Frequency Response: 20Hz-20KHz $\pm .5\text{dB}$.

Input Impedance: 25K ohms, nominal.

Total Harmonic Distortion: Less than .5%, 20Hz-20KHz at +20dBm.

X. PS-MODA Specifications

Connectors: XLR type wired with pin 1 as ground, pin 2 as positive (+) and pin 3 as negative (-). Also, three terminal barrier block.

Signal to Noise: -108dB (from rated output of PS-400).

Frequency Response: DC-25KHz $\pm .25\text{dB}$.

Input Impedance: 20K ohms, nominal.

Total Harmonic Distortion: Less than .5%, 20Hz-20KHz at +20dBm.



XI. Panel Configuration

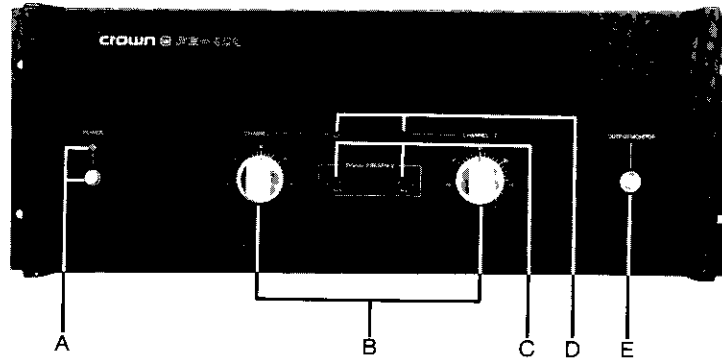

- A. POWER SWITCH/INDICATOR
- B. INPUT LEVEL CONTROLS
- C. SIGNAL PRESENCE INDICATORS
- D. IOC INDICATORS
- E. OUTPUT MONITOR JACKS

Fig. RVW. 1 PS-400 Front Panel

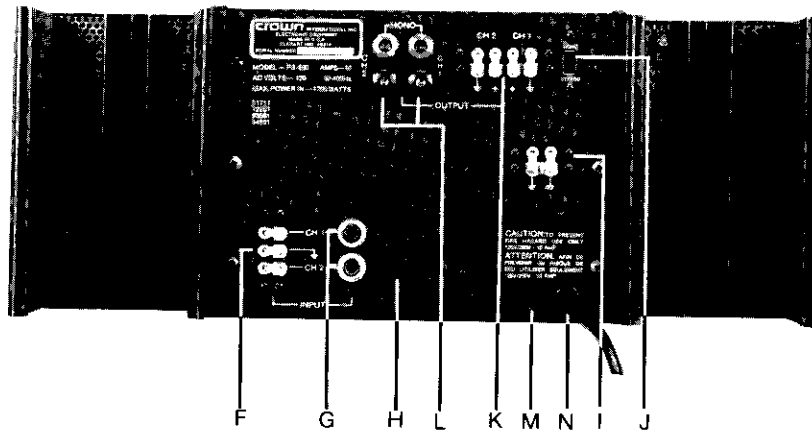

- F. INPUT BARRIER STRIP
- G. INPUT PHONE JACKS
- H. BALANCED INPUT MODULE RECEPTACLE
- I. GROUND TERMINAL STRIP
- J. MONO/STEREO STRIP
- K. OUTPUT BARRIER STRIP
- L. MAIN OUTPUT JACKS
- M. FUSE
- N. AC LINE CORD

Fig. RVW. 2 PS-400 Back Panel

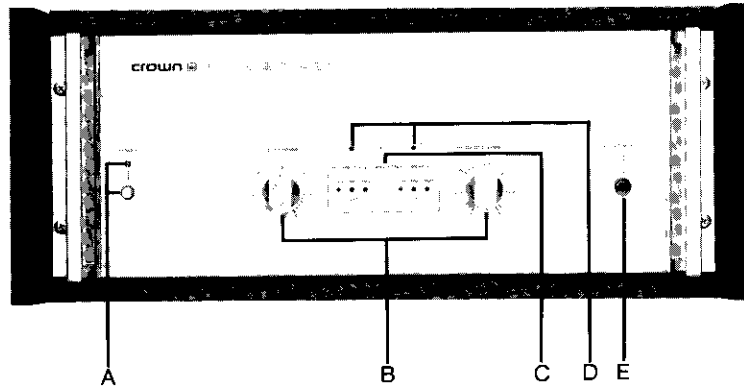

- A. POWER SWITCH/INDICATOR
- B. INPUT LEVEL CONTROLS
- C. FREQUENCY ANALYZING DISPLAY
- D. IOC INDICATORS
- E. OUTPUT MONITOR

Fig. RVW. 3 Power Line Four Front Panel

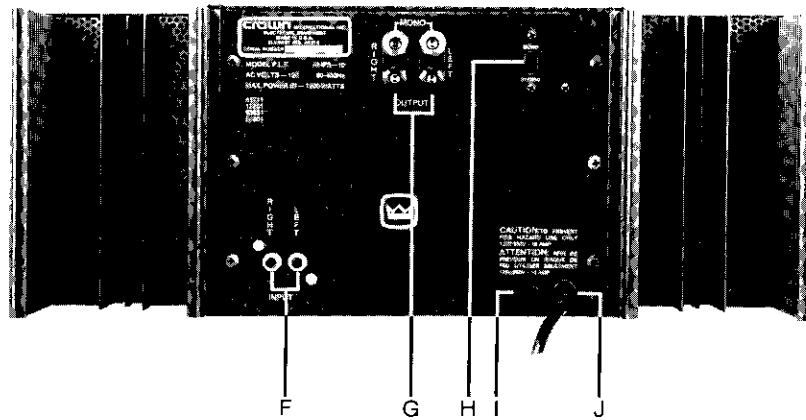

- F. INPUT PHONE JACKS
- G. MAIN OUTPUT JACKS
- H. MONO/STEREO SWITCH
- I. FUSE
- J. AC LINE CORD

Fig. RVW. 4 Power Line Four Rear Panel



XII. Performance Graphs

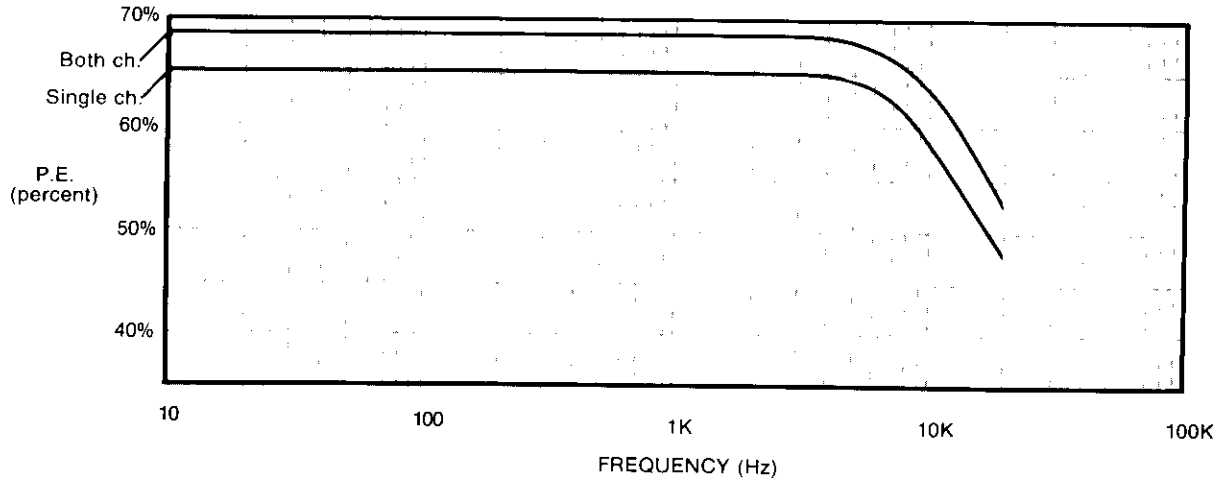

**BOTH CHANNELS DRIVEN TO MAXIMUM UNDISTORTED LEVEL
120 VAC LINE IN
8 OHM LOAD**

Fig. RVW. 5 Nominal Power Efficiency

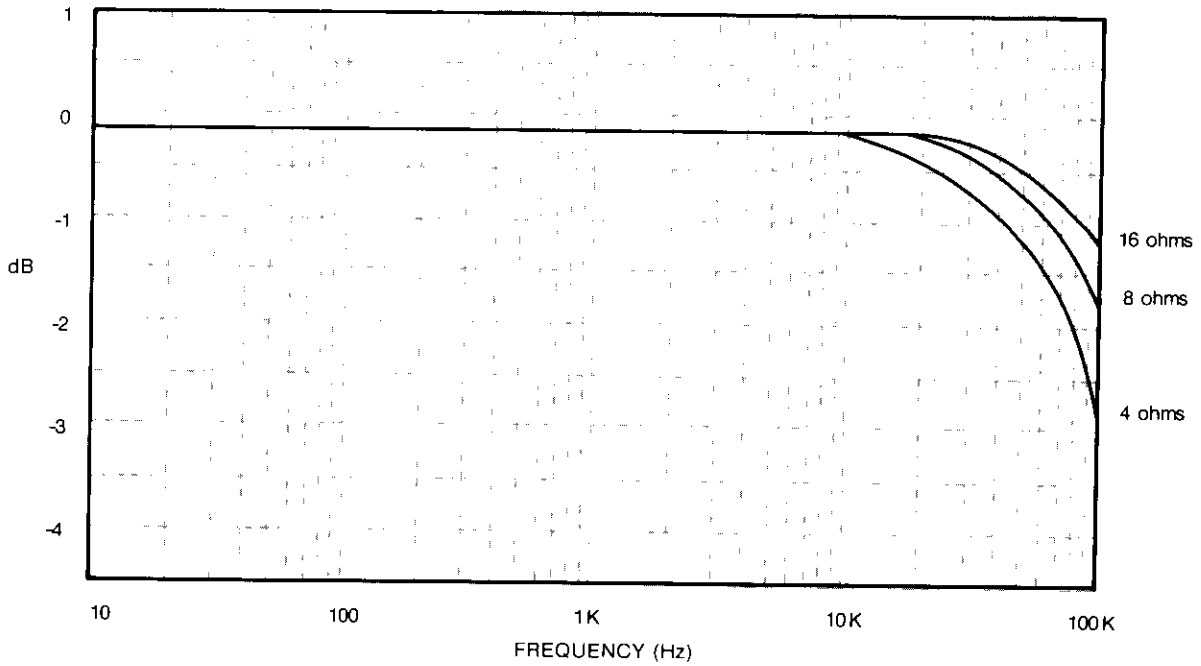

Fig. RVW. 6 Nominal Frequency Response

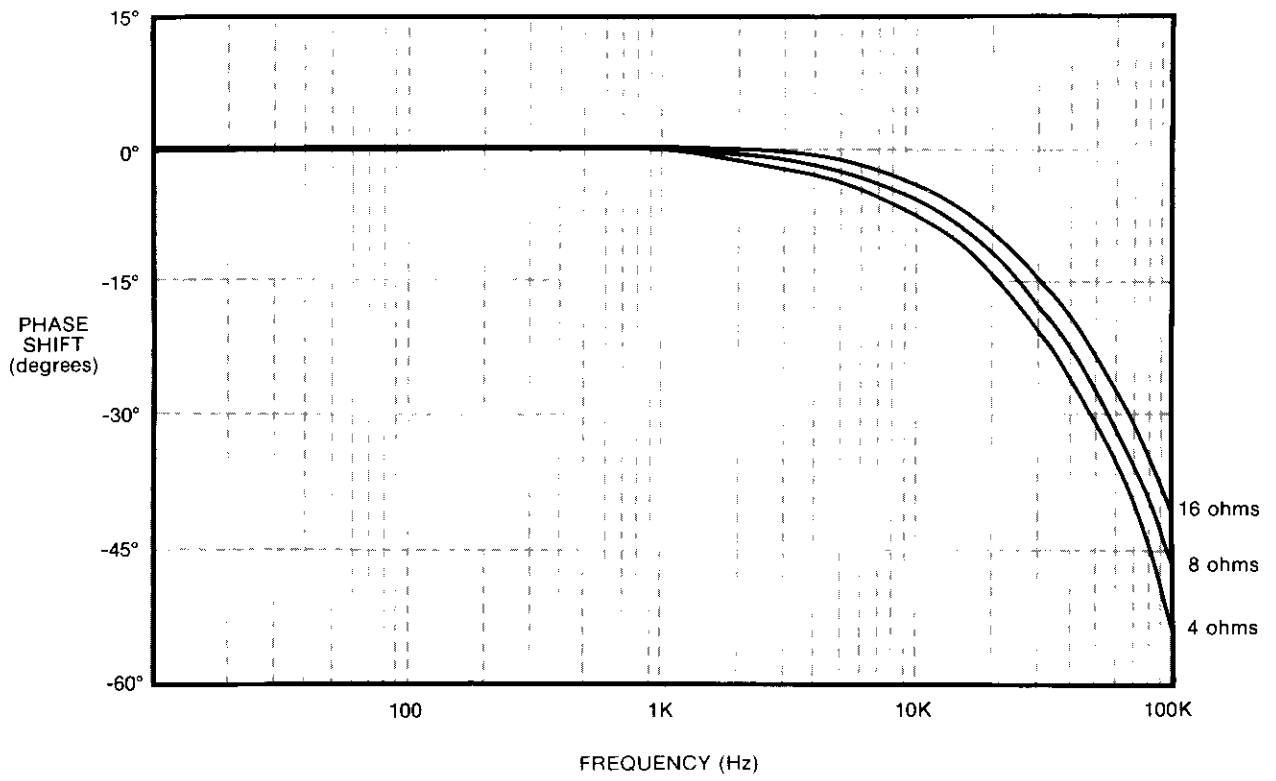

Fig. RVW. 7 Nominal Phase Response

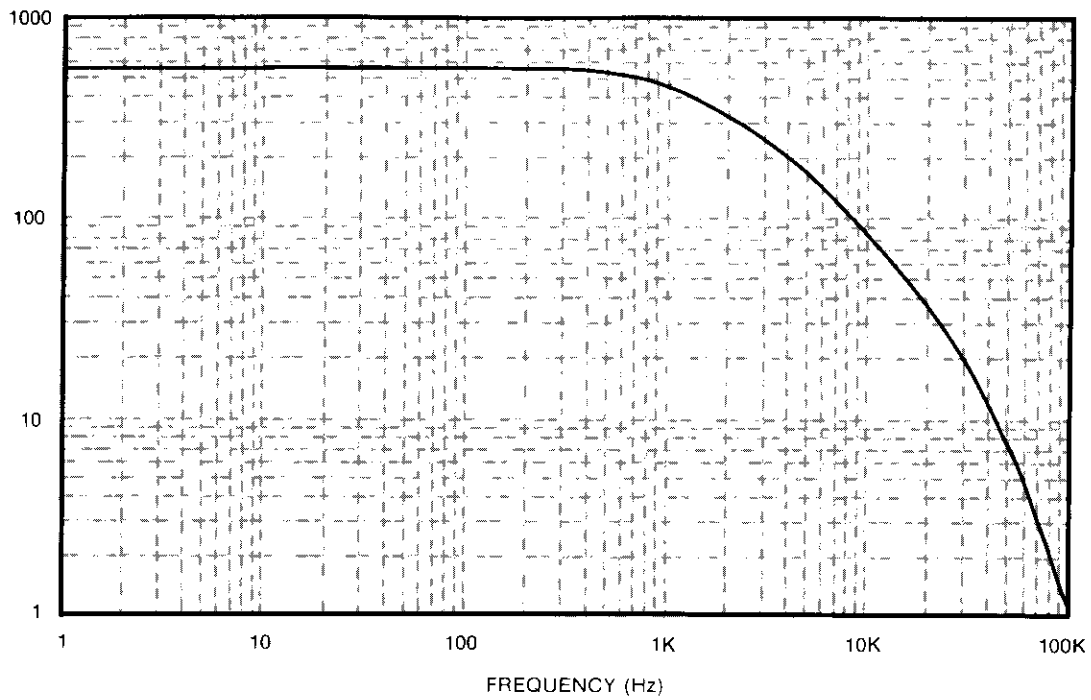

Fig. RVW. 8 Typical Damping Factor (8 ohms)

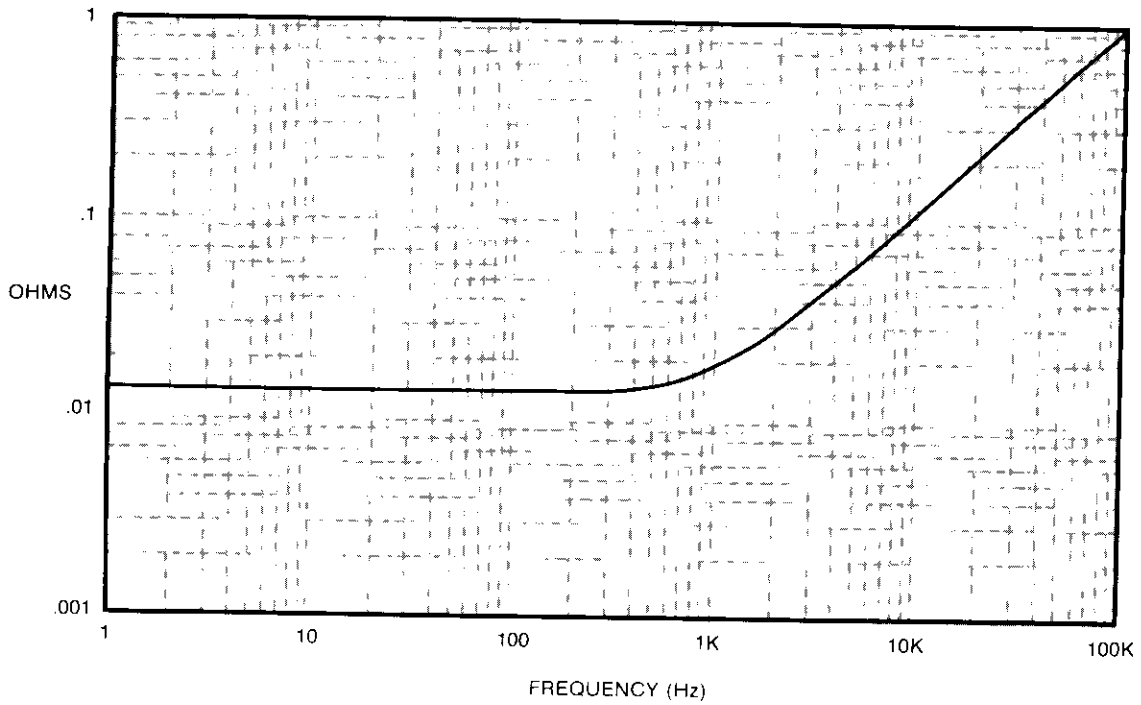
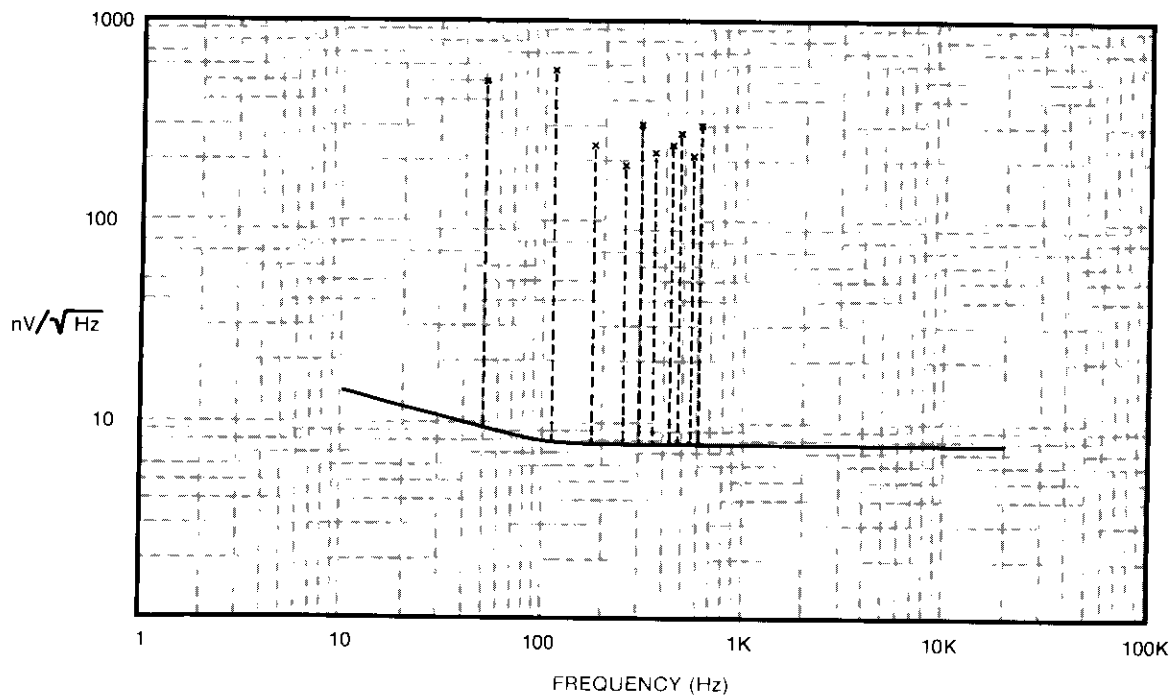
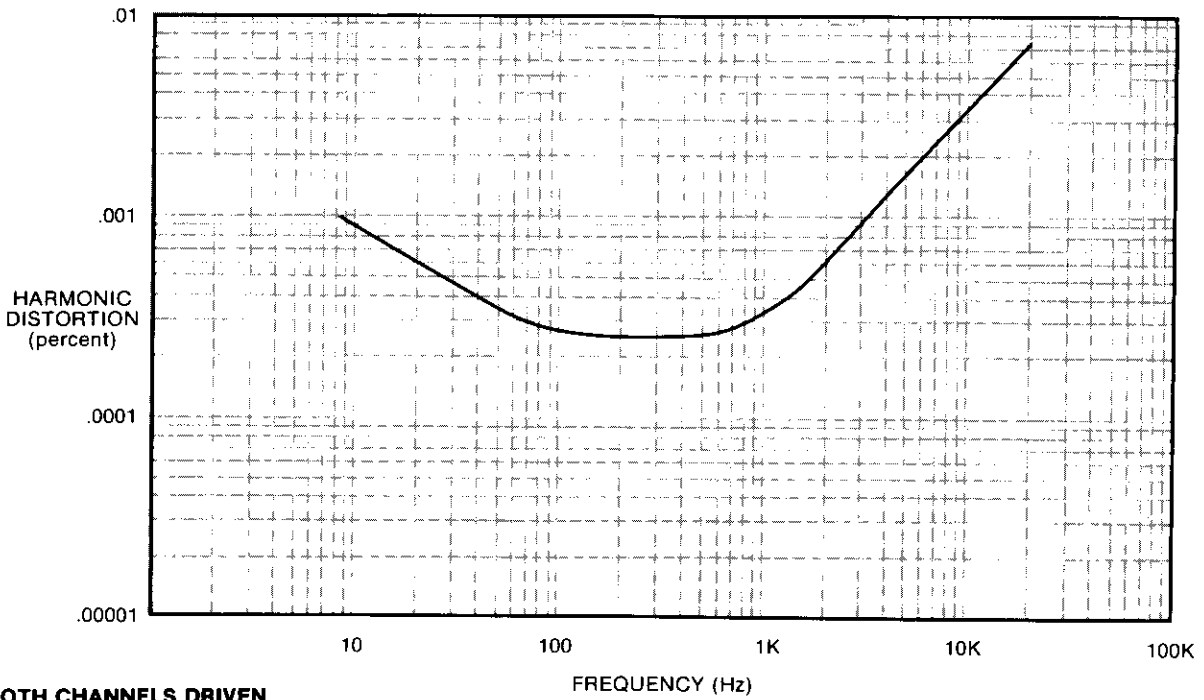

Fig. RVW. 9 Typical Output Impedance



**LINE FREQUENCY HARMONICS PLOTTED TO THE TENTH
OUTPUT IS INDICATED BY (X) ON EXTENDED DOTTED LINES**

Fig. RVW. 10 Nominal Noise Spectrum



**BOTH CHANNELS DRIVEN
165 WATTS INTO 8 OHMS**

Fig. RVW. 11 Harmonic Distortion

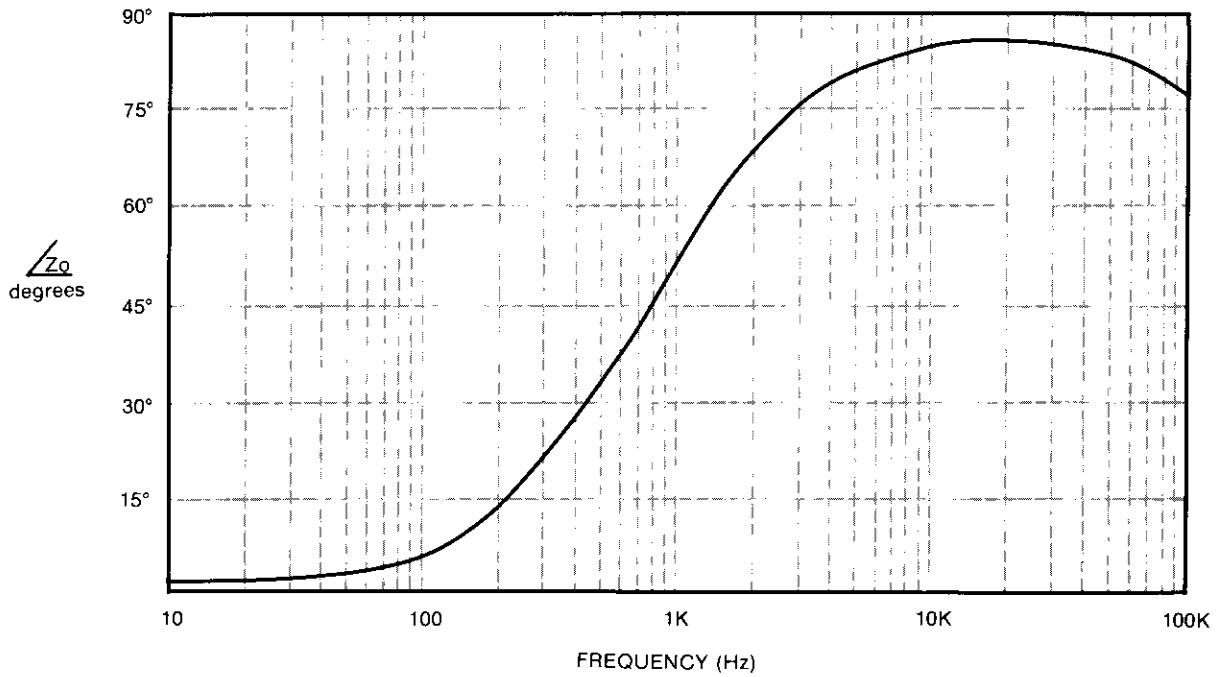
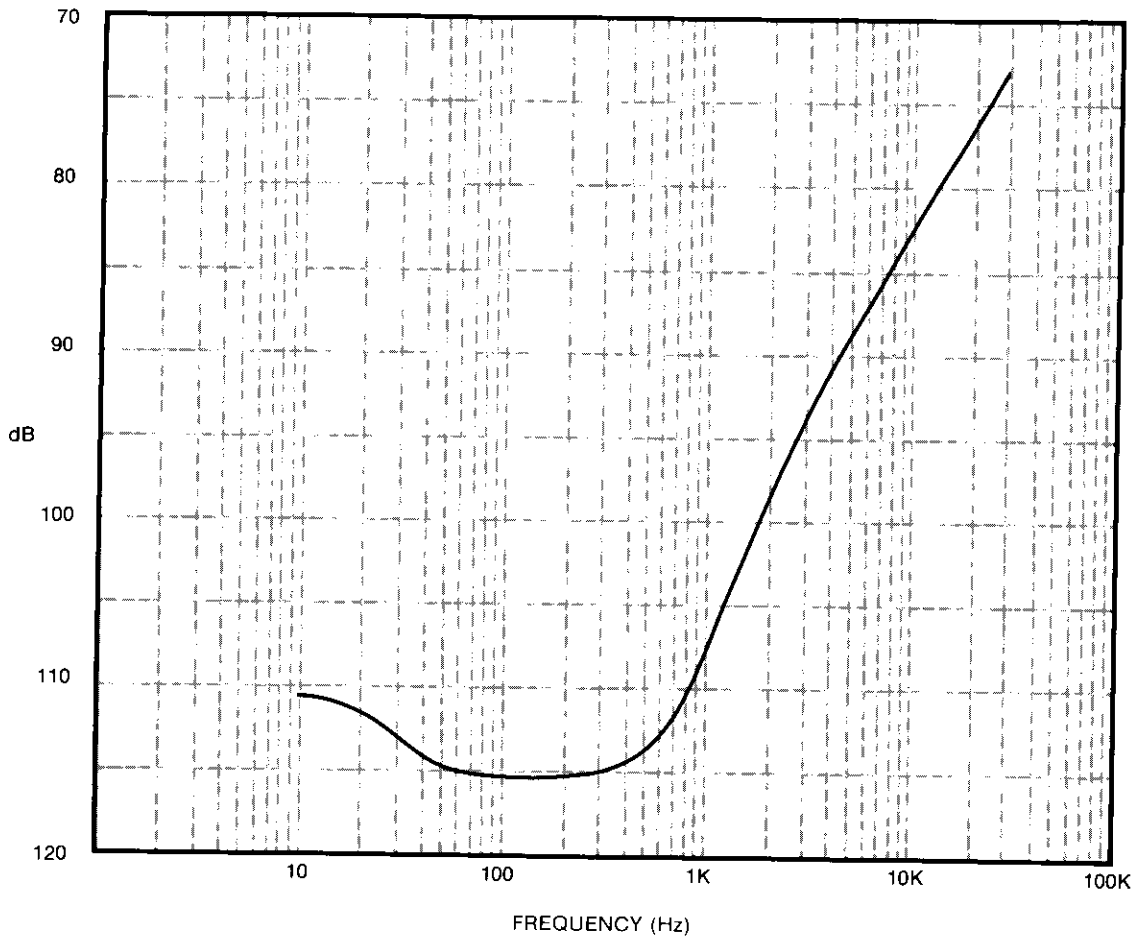

Fig. RVW. 12 Nominal Output Phase Angle



**ONE CHANNEL DRIVEN AT 165 WATTS
1K OHM TERMINATOR USED ON NON-DRIVEN INPUT**

Fig. RVW. 13 Typical Crosstalk

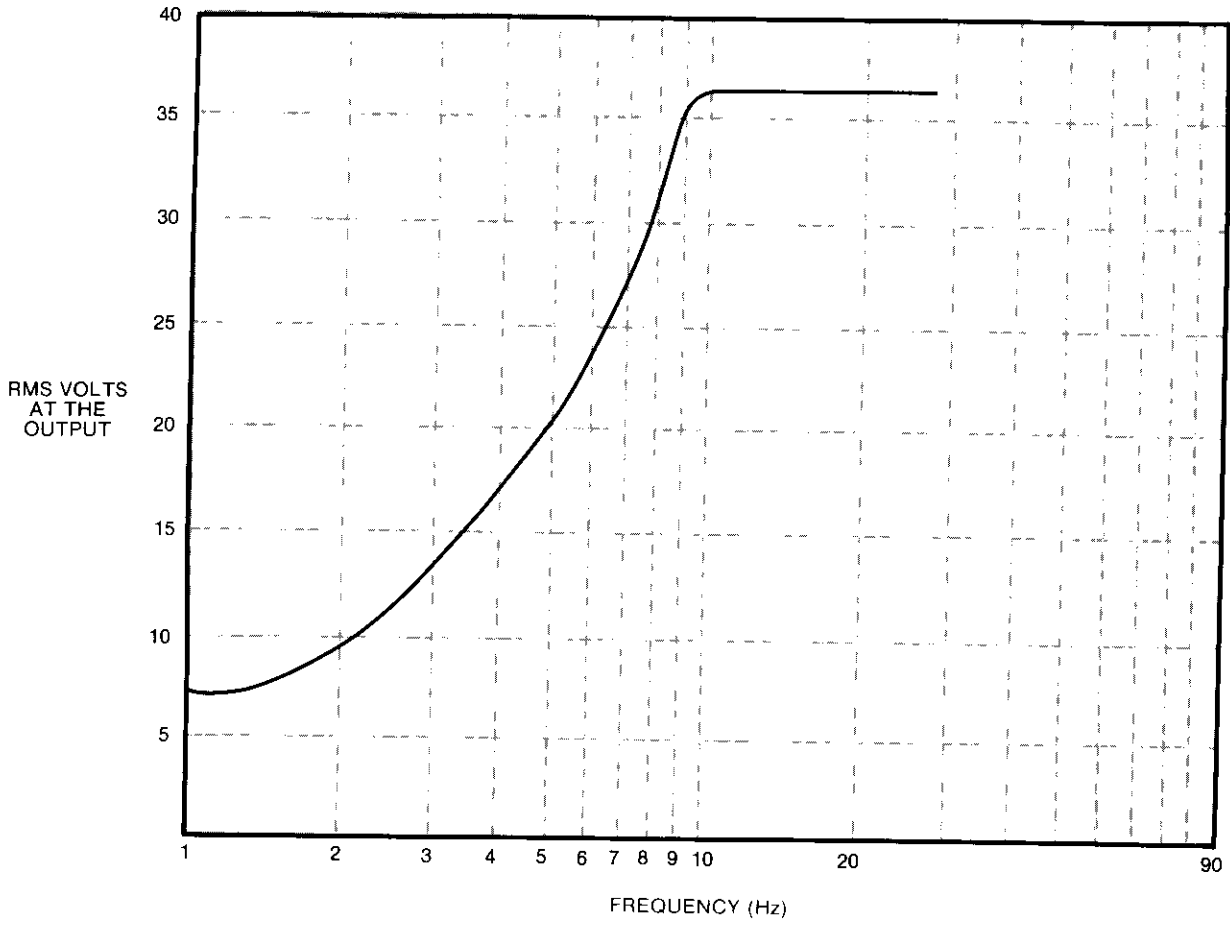

Fig. RVW. 14 Low Frequency Interrupt Action



SECTION 6

ILLUSTRATED PARTS LIST

6.1 General Information

Section 6 contains illustrations and parts lists for the PS-400/Power Line Four. This information should be used with the service, repair and adjustment procedure in Section 7.

Most of the mechanical and structural type parts are illustrated and indexed on exploded view drawings. Electrical and electronic parts on these illustrations are also identified by the circuit schematic designation next to the illustration. Both the index number and the schematic designation are included in the parts list in separate columns. The schematic designations correspond to those shown in schematic diagrams in the Review Section.

Electrical and electronic parts located on printed circuit boards are illustrated by schematic symbols on the trace side and by component shape symbols on the component side. Schematic designations also appear on these diagrams.

The quantity of each part used in each location is also shown in the parts listing.

6.2 Standard and Special Parts

Many electrical and electronic parts used in the PS-400/Power Line Four are standard items stocked by and available from electronic supply houses. However, some electronic parts that appear to be standard, are actually special. A part ordered from Crown will assure an acceptable replacement. Structural items, covers and panels are available from Crown only.

6.3 Ordering Parts

When ordering parts, be sure to give the model and serial number and include the part description and Crown Part Number (CPN) from the parts list. Price quotes are available upon request.

6.4 Shipment

1. Shipment will be made by UPS or best method unless you specify a preferred method.
2. Shipments are made F.O.B. Elkhart, Indiana only.
3. Established Crown accounts will be freight prepaid and billed unless shipped by truck or air freight.
4. All others will be shipped freight collect.

6.5 Terms

1. Normal terms are C.O.D. unless the order is prepaid.
2. Net 30 days terms apply only to those firms who have an established line of credit with Crown.
3. If prepaying please add an amount for the freight charge. \$1.00 is average for an order under one pound.

NOTE: Part prices are subject to change without notice.

4. New parts returned for credit are subject to a 10% restocking charge.
5. You must receive authorization from the Parts Dept. before returning parts for credit.
6. We are not a general parts warehouse! Parts are available for servicing Crown products only.

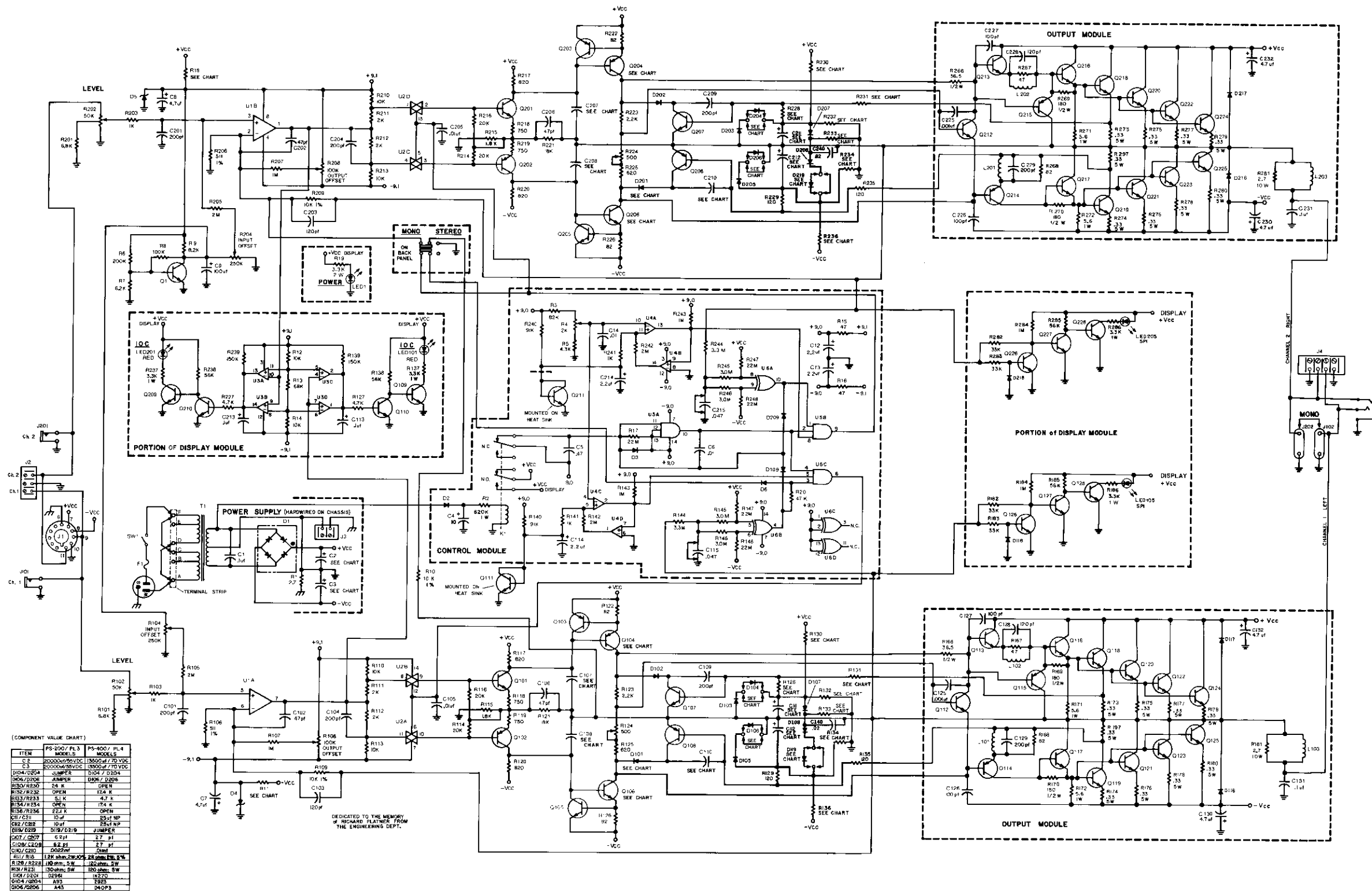

PS-400 SCHEMATIC NOTES

- CIRCUIT SHOWN APPLIES TO UNITS WITH SN31024 AND ABOVE.
- ALL RESISTORS ARE IN OHMS, ALL CAPACITORS IN MICROFARADS UNLESS OTHERWISE DESIGNATED.
- ALL RESISTORS ARE .25 WATT, 5% TOLERANCE UNLESS OTHERWISE DESIGNATED.
- COMPONENTS COMMON TO BOTH CHANNELS ARE NUMBERED FROM 1 TO 99.
- CHANNEL ONE COMPONENTS ARE NUMBERED FROM 100 TO 199.
- CHANNEL TWO COMPONENTS ARE NUMBERED FROM 200 TO 299.
- MONO/STEREO SWITCH SHOWN IN THE MONO POSITION.
- +VCC IS 62 VOLTS.

Fig. 6.1 PS-400 Schematic

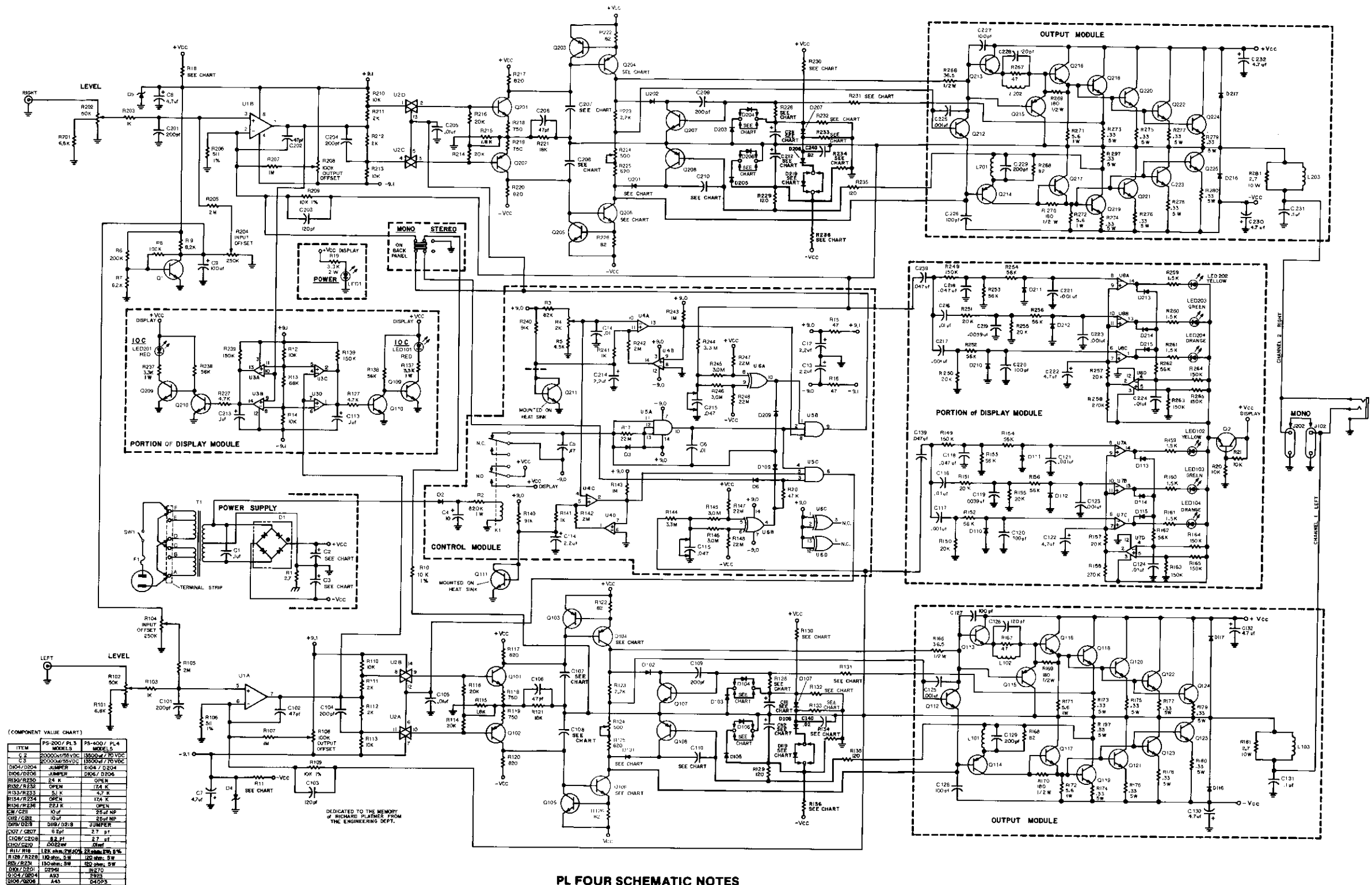

PL FOUR SCHEMATIC NOTES

- **CIRCUIT SHOWN APPLIES TO UNITS WITH SN3024 AND ABOVE.**
- **ALL RESISTORS ARE IN OHMS, ALL CAPACITORS IN MICROFARADS UNLESS OTHERWISE DESIGNATED.**
- **ALL RESISTORS ARE .25 WATT, 5% TOLERANCE UNLESS OTHERWISE DESIGNATED.**
- **COMPONENTS COMMON TO BOTH CHANNELS ARE NUMBERED FROM 1 TO 99.**
- **LEFT CHANNEL COMPONENTS ARE NUMBERED FROM 100 TO 199.**
- **RIGHT CHANNEL COMPONENTS ARE NUMBERED FROM 200 TO 299.**
- **MONO/STEREO SWITCH SHOWN IN THE MONO POSITION.**
- **+VCC IS 62 VOLTS.**

Fig. 6.2 Power Line Four Schematic

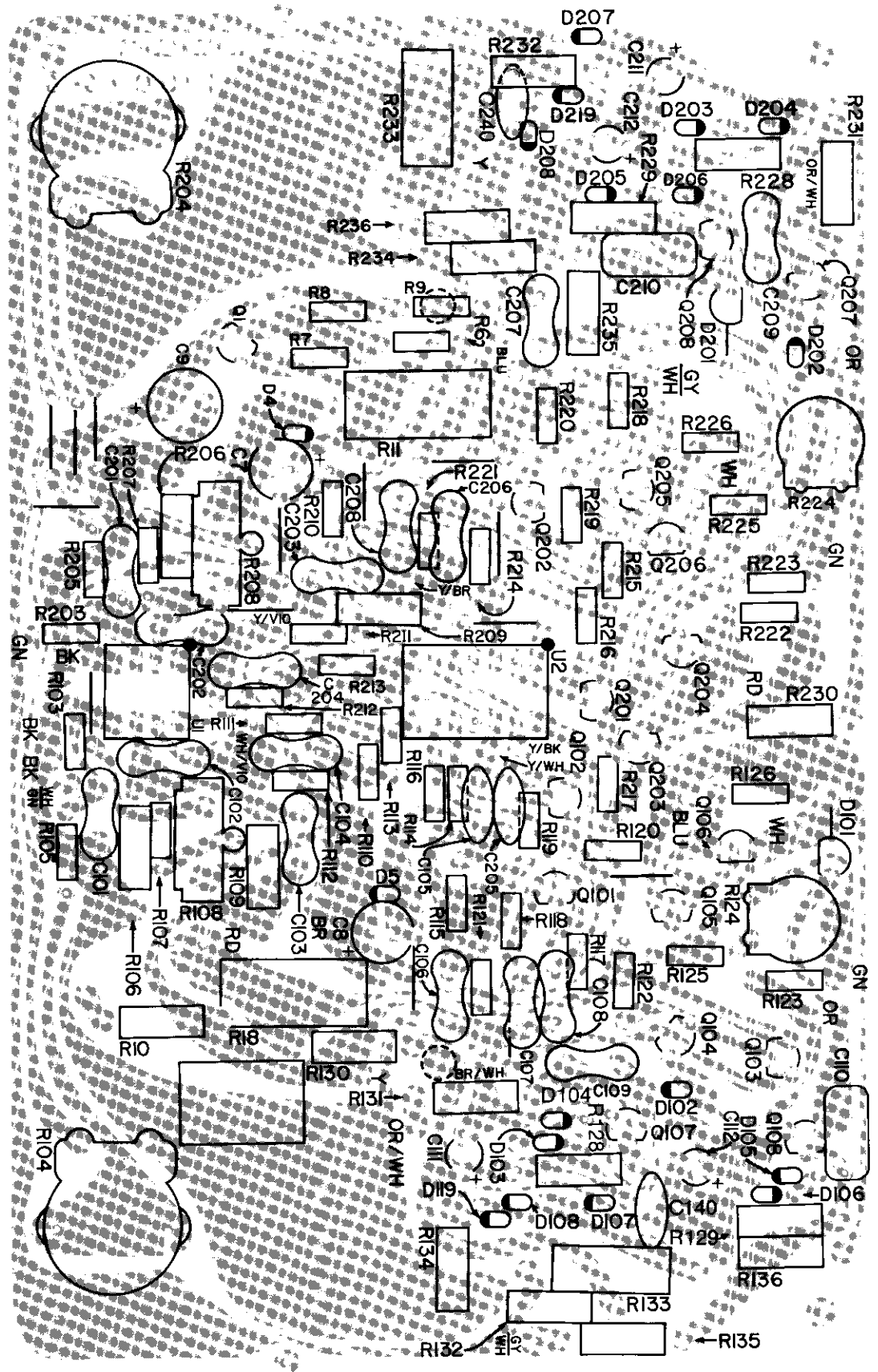

Fig. 6.3 PS-400/Power Line Four Main Component Board Layout; P10026-6

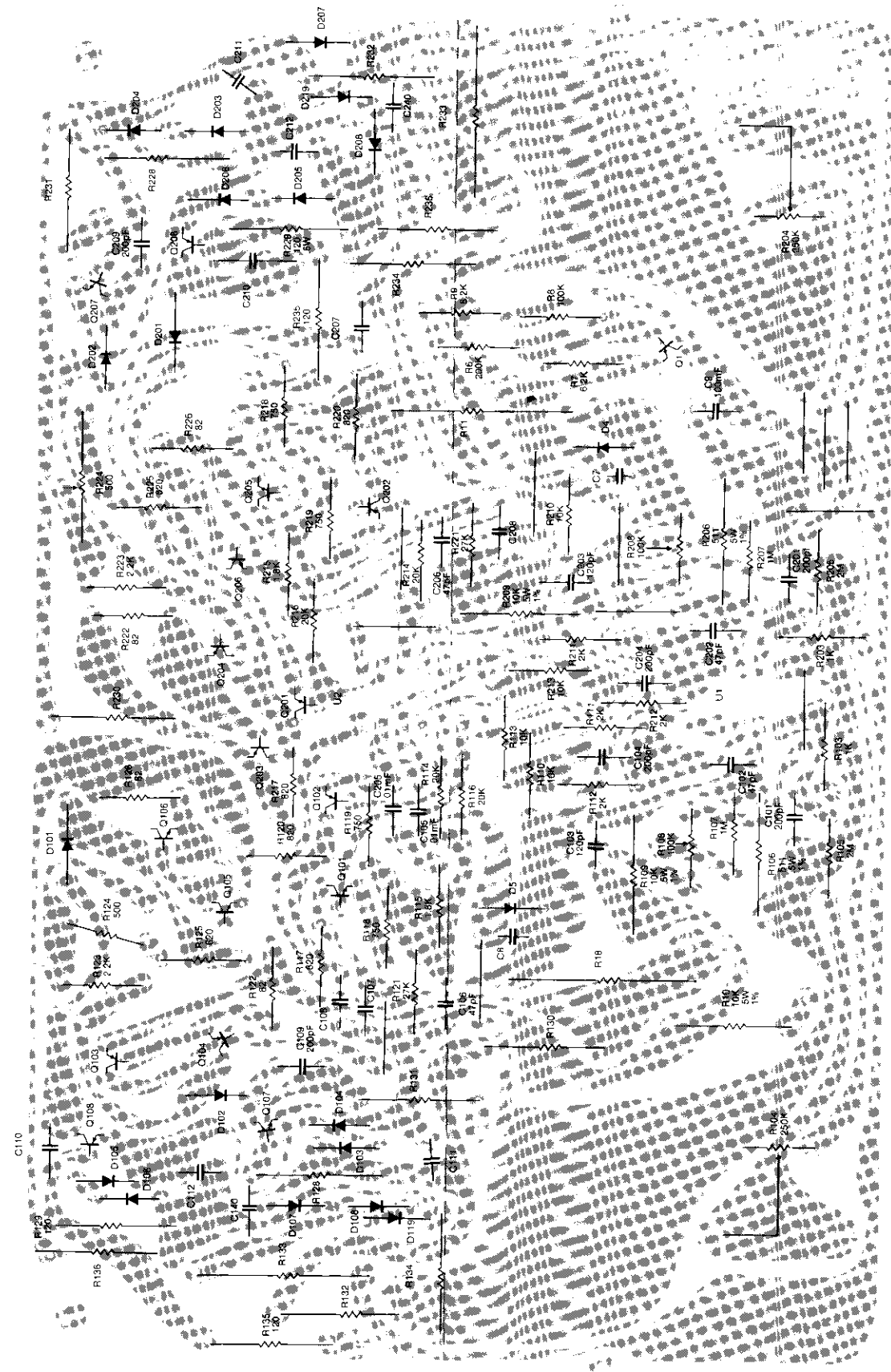

Fig. 6.4 PS-400/Power Line Four Main Foil Board Layout; P10026-6

Schematic Designation	Description	Crown Part No.	Qty.	Other Information
Resistors				
R6	200K ohm .25W 5%	C 3622-5	1	
R7	6.2K ohm .25W 5%	C 3619-1	1	
R8	100K ohm .25W 5%	C 2883-4	1	
R9	8.2K ohm .25W 5%	C 2877-6	1	
R10,				
R109, R209	10K ohm .5W 1%	C 2343-9	3	
R11, R18	2K ohm 2W 5%	C 3651-4	2	
R103, R203	1K ohm .25W 5%	C 2627-5	2	
R104, R204	250K ohm Horz. White Pot	C 3087-1	2	
R105, R205	2M ohm .25W 5%	C 3199-4	2	
R106, R206	511 ohm .5W 1%	C 3304-0	2	
R107, R207	1M ohm .25W 5%	C 3198-6	2	
R108, R208	100K ohm Vertical White Pot	C 1713-4	2	
R110, R210,				
R113, R213	10K ohm .25W 5%	C 2631-7	4	
R111, R211,				
R112, R212	2K ohm .25W 5%	C 3804-9	4	
R114, R214,				
R116, R216	20K ohm .25W 5%	C 5046-5	4	
R115, R215	1.8K ohm .25W 5%	C 3807-2	2	
R117, R217,				
R120, R220	820 ohm .25W 5%	C 3301-6	4	
R118, R218,				
R119, R219	750 ohm .25W 5%	C 3803-1	4	
R121, R221	27K ohm .25W 5%	C 5165-3	2	
R122, R222,				
R126, R226	82 ohm .25W 5%	C 3960-9	4	
R123, R223	2.2K ohm .25W 5%	C 2628-3	2	
R124, R224	500 ohm Piher Trim	C 6048-0	2	
R125, R225	620 ohm .25W 5%	C 3872-6	2	
R128, R228,				
R129, R229,				
R131, R231,				
R135, R235	120 ohm .5W 5%	C 3837-9	8	
R132, R232,				
R134, R234	17.4K ohm .25W 1%	C 4498-9	4	
R133, R233	4.7K ohm 1W 5%	C 5964-9	2	
Capacitors				
C7, C8	4.7mF 63V	C 4253-8	2	Supersede C 4019-3
C9	100mF 16V	C 3729-8	1	
C101, C201,				
C104, C204,				
C109, C209	200pF	C 3411-3	6	
C102, C202,				
C106, C206	47pF	C 3409-7	4	
C103, C203	120pF	C 3290-1	2	
C105, C205,				
C110, C210	.01mF 500V	C 1751-4	4	

Schematic Designation	Description	Crown Part No.	Qty.	Other Information
C107, C207,				
C108, C208	27pF	C 2342-1	4	
C111, C211,				
C112, C212	22mF 50V NP 10%	C 5311-3	4	
Diodes				
D4, D5	IN960B 9.1V Zener	C 5900-3	2	
D101, D201	1N270	C 3447-7	2	
D102, D202,				
D103, D203,				
D104, D204,				
D105, D205,				
D106, D206,				
D107, D207,				
D108, D208,				
D109, D209	1N4148	C 3181-2	16	
Transistors				
Q1,				
Q105, Q205,				
Q107, Q207	SEL 2N3859A	C 2961-7	5	
Q101, Q201	MPSA43	C 3810-6	2	
Q102, Q202	MPSA93	C 3578-9	2	
Q103, Q203,				
Q108, Q208	2N4125	C 3625-8	4	
Q104, Q204	SEL 2N4929 SS7304PNP	C 2923-7	2	
Q106, Q206	D40P3	C 5065-5	2	
Integrated Circuits				
U1	NE5532AP Dual Op-Amp	C 5881-5	1	
U2	MC14016 Quad Switch	C 4834-5	1	
Miscellaneous				
	8 pin DIL IC Socket	C 3451-9	1	Socket for U1
	14 pin DIL IC Socket	C 3450-1	1	Socket for U2
	T05 MTG PAD	C 1250-7	2	
	298 T05 Cooler	C 4414-6	2	
	Board, Main PS/PL	Q42454-1	1	Fully assembled board

Schematic Designation	Description	Crown Part No.	Qty.	Other Information
Resistors				
R2	820 ohm 1W 5%	C 3648-0	1	
R3	82K .25W 5%	C 4212-4	1	
R4	2K ohm vert red lin	C 2871-9	1	
R5	4.3K ohm .25W 5%	C 4855-0	1	
R15, R16	47 ohm .25W 5%	C 1011-3	2	
R17, R147, R247, R148, R248	22M ohm .25W 5%	C 5215-6	5	
R20	47K ohm .25W 5%	C 2880-0	1	
R140, R240	91K ohm .25W 5%	C 3621-7	2	
R141, R241	1K ohm .25W 5%	C 2627-5	2	
R142, R242	2M ohm .25W 5%	C 3199-4	2	
R143, R243	1M ohm .25W 5%	C 3198-6	2	
R144, R244	3.3M ohm .25W 5%	C 4237-1	2	
R145, R245, R146, R246	3M ohm .25W 5%	C 4489-8	4	
Capacitors				
C4	10mF 50V	C 3728-0	1	Supersedes C 5050-7
C5	.47mF	C 4119-1	1	
C6, C14	.01mF	C 1751-4	2	
C12, C13, C114, C214	2.2mF	C 5362-6	4	
C115, C215	.047mF	C 3978-1	2	
Diodes				
D2	IN4004	C 2851-1	1	
D3, D6, D109, D209	IN4148	C 3181-2	4	
Integrated Circuits				
U4	LM339N Volt Comparator	C 4345-2	1	
U5	MC14073 3INP ANDGATE	C 5902-9	1	
U6	MC14070 EXCLV. or GATE	C 4833-7	1	
Relay				
K1	1.28K ohm	C 5898-9	1	
Miscellaneous				
	14 Pin IC socket	C 3450-1	3	socket for U4, U5, U6
	Board, Control PS/PL	Q42453-3	1	Fully assembled board

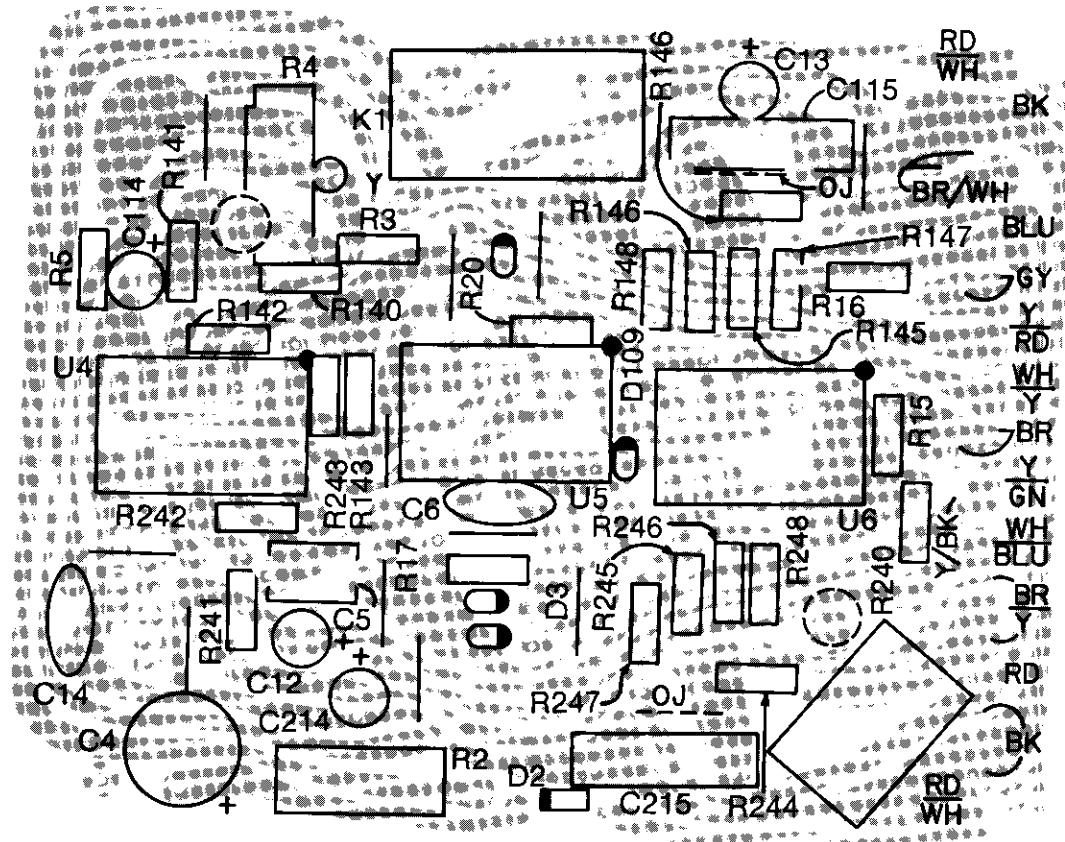

Fig. 6.5 PS-400/Power Line Four Control Module Component Board Layout; P 9983B7

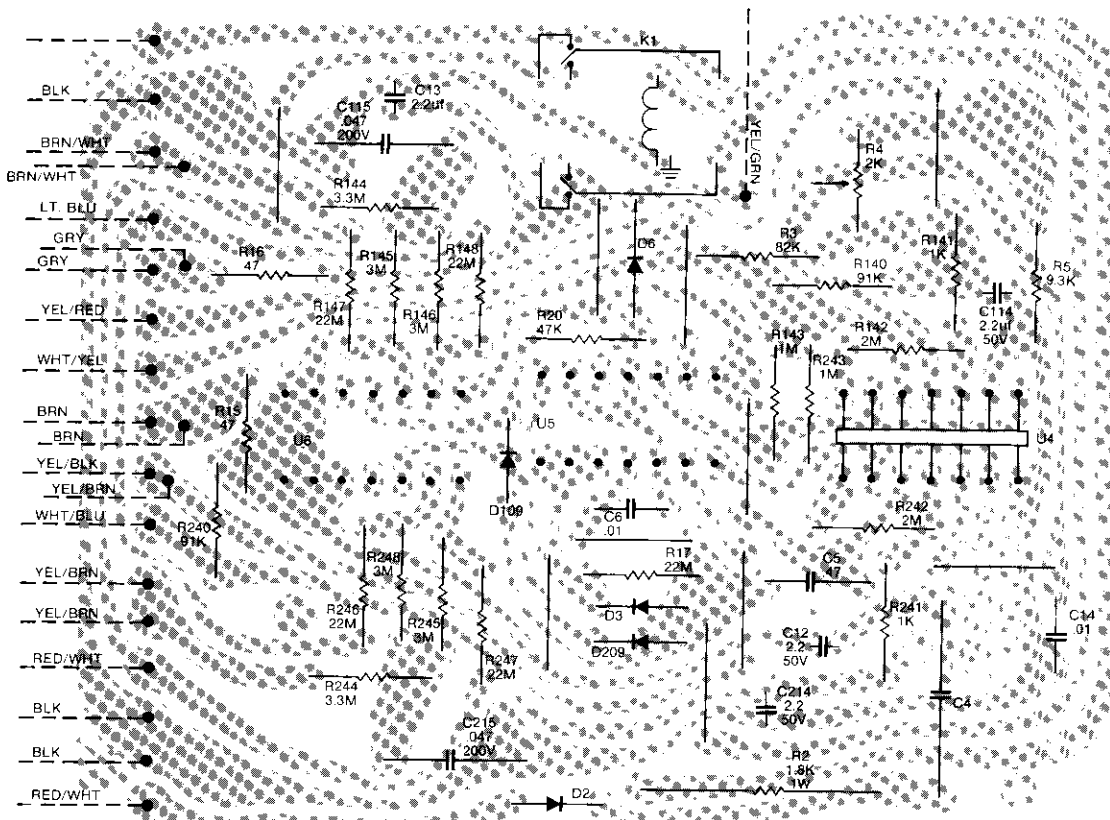

Fig. 6.6 PS-400/Power Line Four Control Module Foil Board Layout; P 9983B7

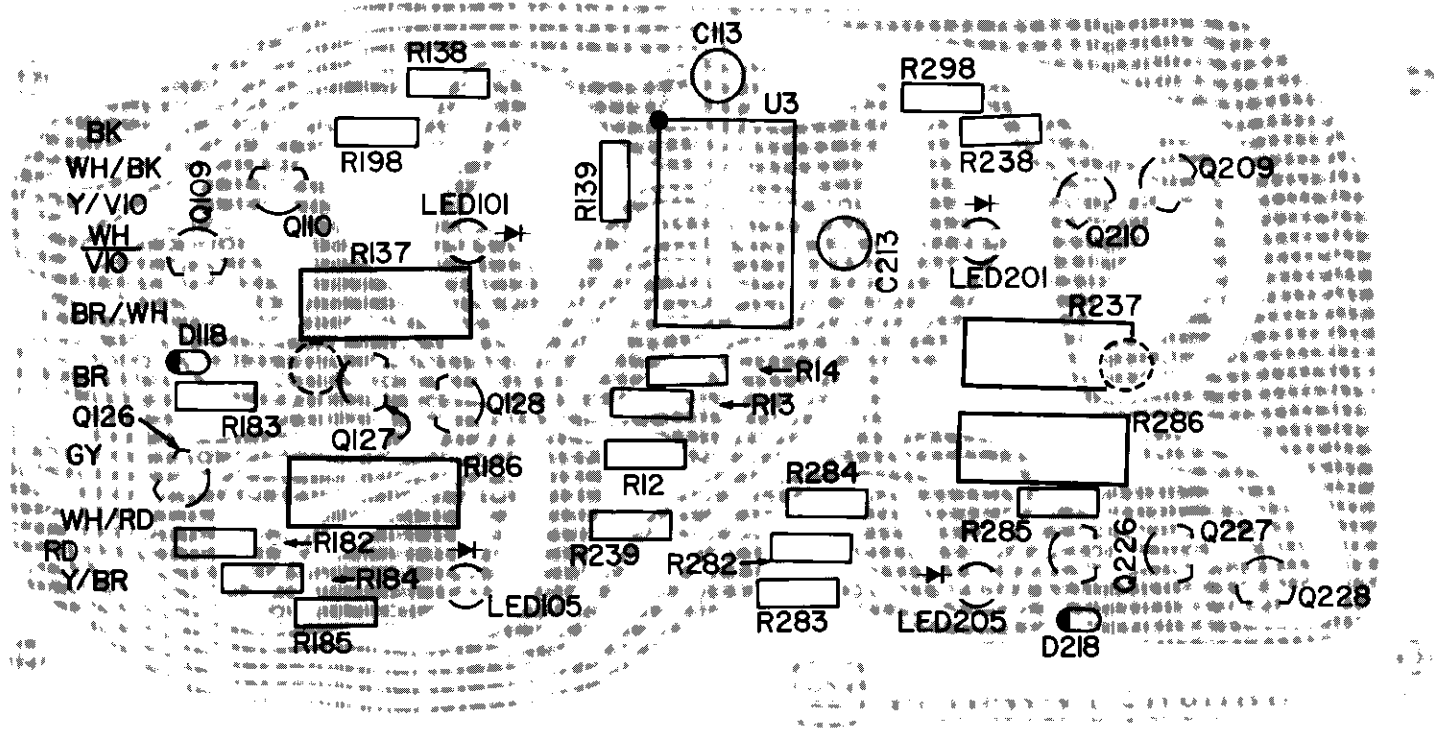

Fig. 6.7 PS-400 Display Module Component Board Layout; P 9980B3

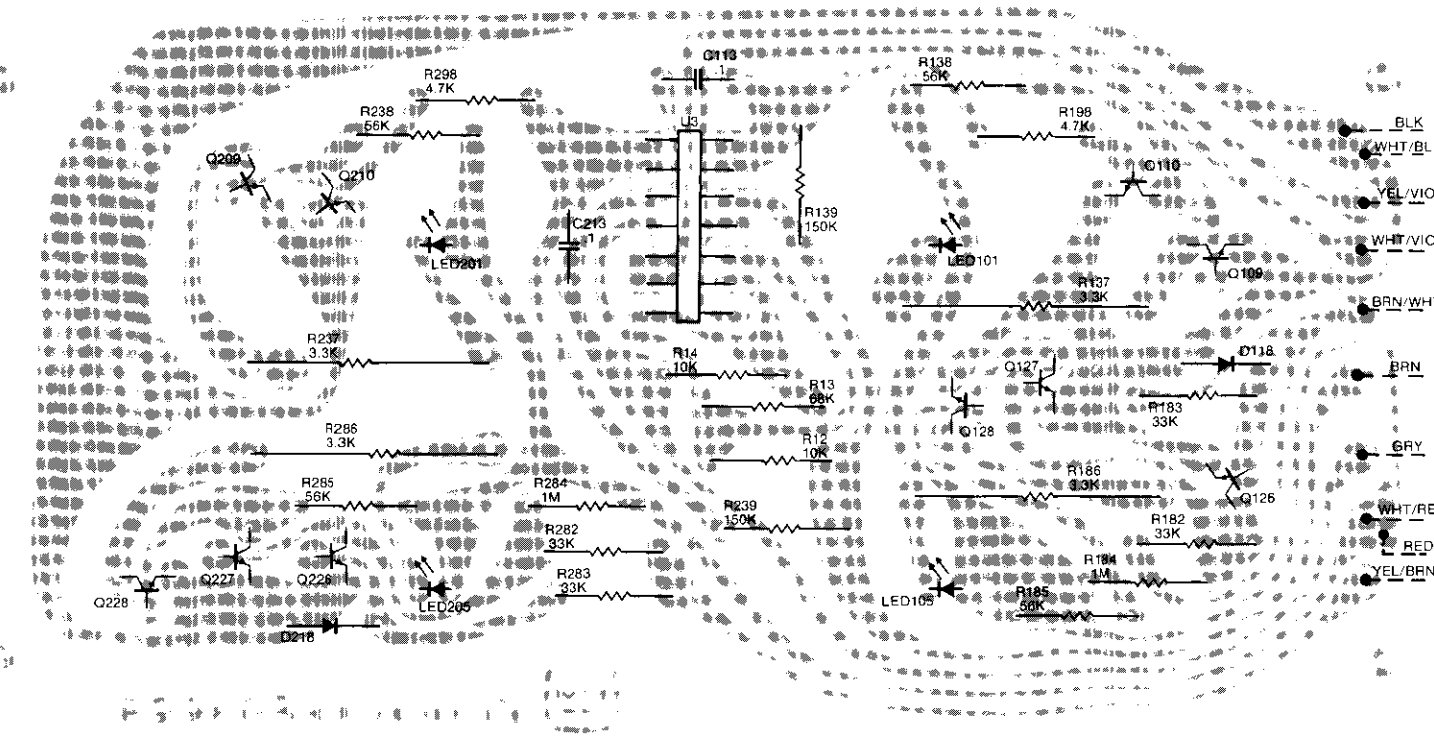

Fig. 6.8 PS-400 Display Module Foil Board Layout; P 9980B3

Schematic Designation	Description	Crown Part No.	Qty.	Other Information
Resistors				
R12, R14	10K ohm .25W 5%	C 2631-7	2	
R13	68K ohm .25W 5%	C 3620-9	1	
R137, R237, R186, R286	3.3K ohm 1W 5%	C 3617-5	4	
R138, R238, R185, R285	56K ohm .25W 5%	C 2882-6	4	
R139, R239	150K ohm .25W 5%	C 4216-5	2	
R182, R282, R183, R283	33K ohm .25W 5%	C 4346-0	4	
R184, R284	1M ohm .25W 5%	C 3198-6	2	
R198, R298	4.7K ohm .25W 5%	C 3939-3	2	
Capacitors				
C113, C213	.1mF	C 5639-7	2	
Diodes				
LED 101, LED 201	T1 RED LED	C 5905-2	2	
LED 105, LED 205	T1 Green LED Long	C 5960-7	2	
D118, D218	1N4148	C 3181-2	2	
Transistors				
Q109, Q209, Q110, Q210, Q126, Q226, Q127, Q227, Q128, Q228	SEL 2N3859A	D 2961-7	10	
Integrated Circuits				
U3	LM339N Volt Comparator	C 4345-2	1	
Miscellaneous				
	14 Pin DIL IC Socket	C 3450-1	1	Socket for U3
	LED Mounts 907-475	C 5914-4	2	Use with LED101, 201
	LED Mounts 907-455	C 6065-4	2	Use with LED 105, 205
	Board, Display PS-200/PS-400	Q42450-9	1	Fully assembled board

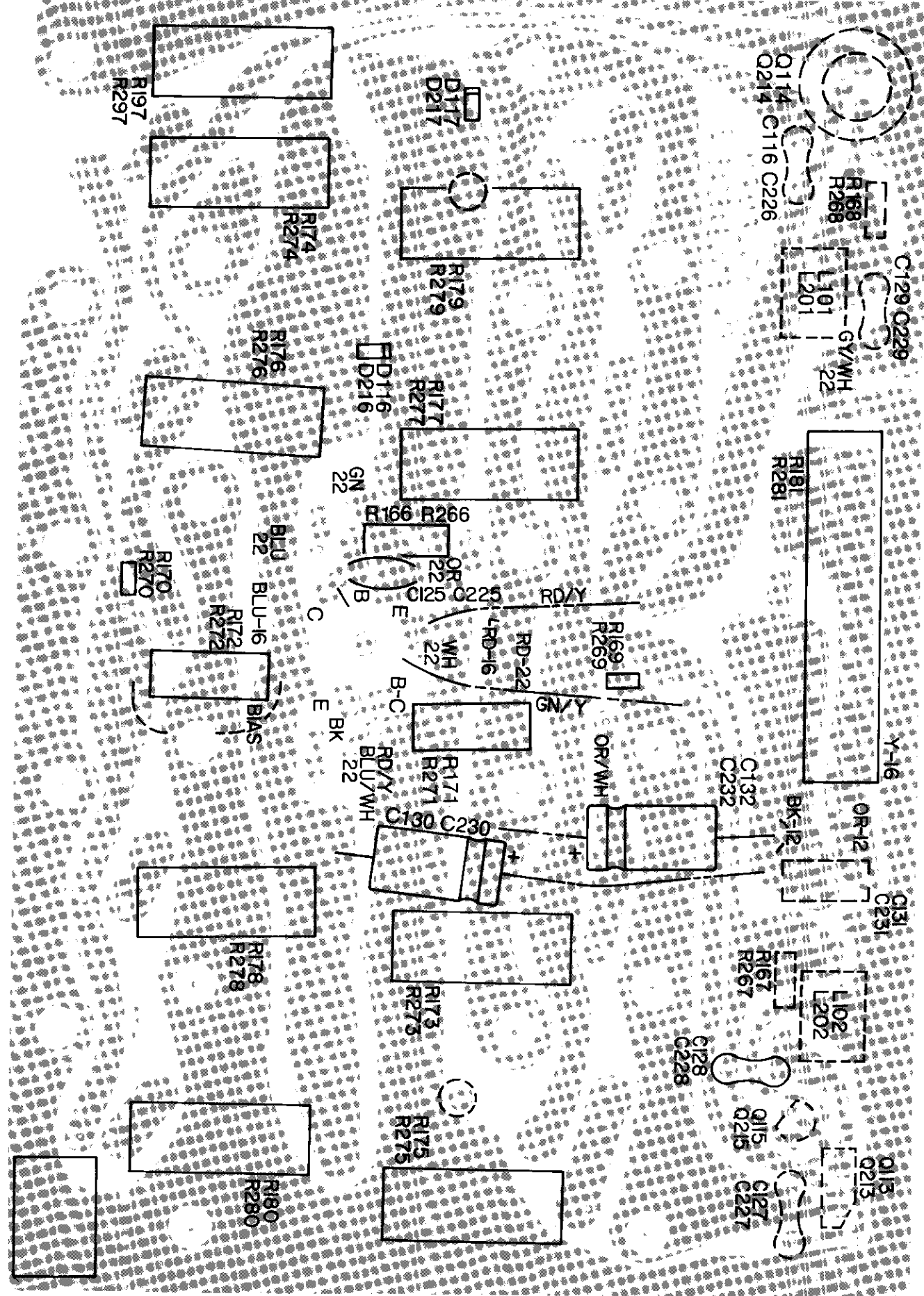

Fig. 6.9 PS-400/Power Line Four Output Module Component Board Layout; M20217-2

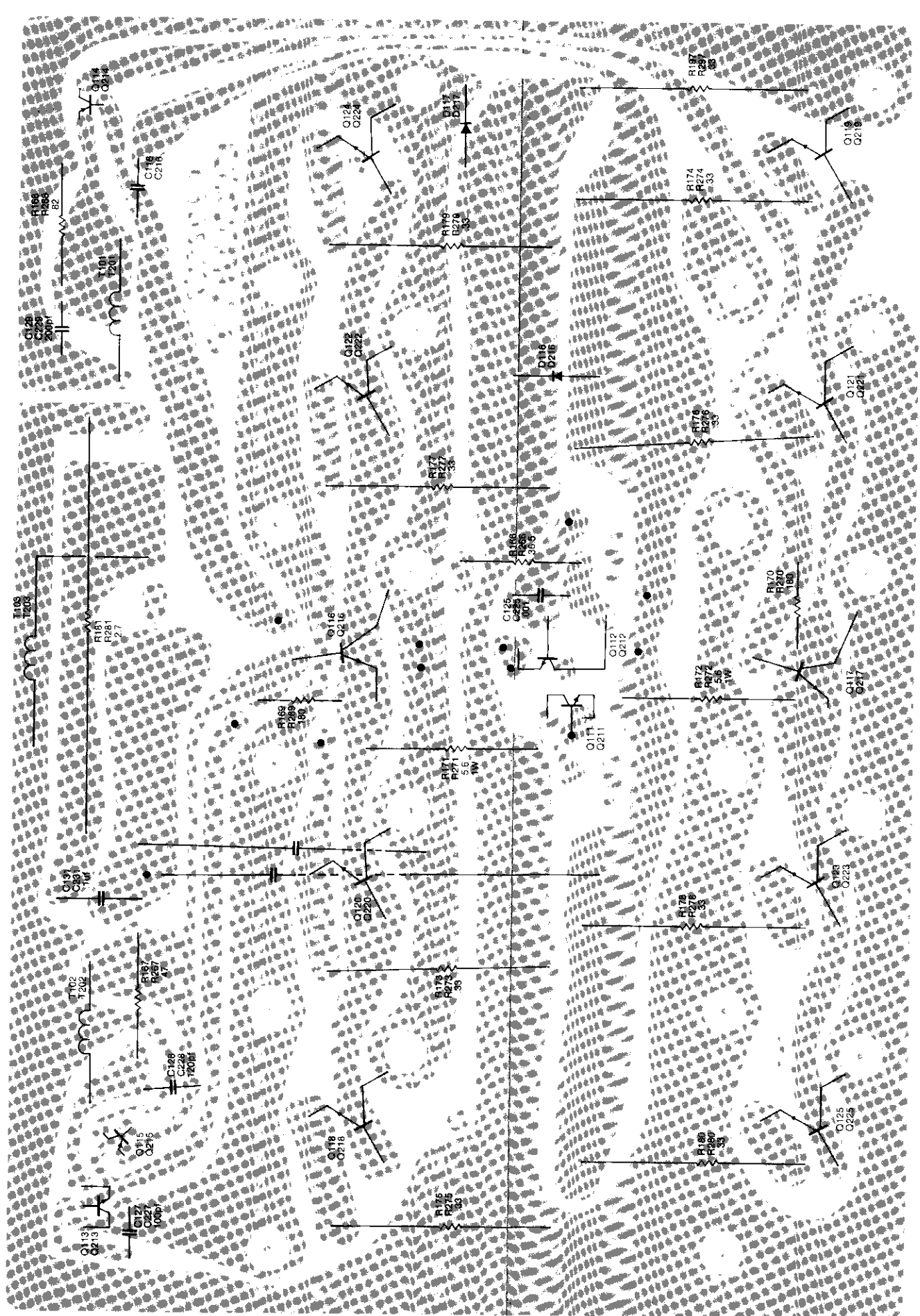

Fig. 6.10 PS-400/Power Line Four Output Module Foil Board Layout; M20217-2

Schematic Designation	Description	Crown Part No.	Qty.	Other Information
Resistors				
R166, R266	36 ohm .5W 5%	C 2988-1	2	
R167, R267	47 ohm .5W 5%	C 2528-5	2	
R168, R268	82 ohm .5W 5%	C 2918-8	2	
R169, R269, R170, R270	180 ohm .25W 5%	C 2873-5	4	
R171, R271, R172, R272	5.6 ohm 1W 5%	C 2355-3	4	
R173, R273, R174, R274, R175, R275, R176, R276, R177, R277, R178, R278, R179, R279, R180, R280, R197, R297	.33 ohm S.W. 5%	C 3583-9	18	
R181, R282	2.7 ohm 10W 10%	C 5862-5	2	
Capacitors				
C125, C225	.001mF	C 2288-6	2	
C126, C226, C127, C227	100pF	C 3410-5	4	
C128, C228	120pF	C 3290-1	2	
C129, C229	200pF	C 3411-3	2	
C130, C230, C132, C232	4.7mF	C 5050-7	4	
C131, C231	.1mF	C 5243-8	2	
Diodes				
D116, D216, D117, D217	IN4004	C 2851-1	4	
Transistors				
Q112, Q212	SEL 2N3859A	D 2961-7	2	
Q113, Q213	D40P3	C 5065-5	2	
Q114, Q214	SEL 2N4929	D 2923-7	2	
Q115, Q215	2N4125	C 3625-8	2	
Q116, Q216, Q117, Q217	MJ4248	C 5889-8	4	
Q118, Q218, Q119, Q219, Q120, Q220, Q121, Q221, Q122, Q222, Q123, Q223,, Q124, Q224, Q125, Q225	MJ15150	D 5841-8	16	

Schematic Designation	Description	Crown Part No.	Qty.	Other Information
Coils				
L101, L201, L102, L202	.5mH Axial Green	C 3510-2	4	
L103, L203	3mh toroid assembly	M42540-1	4	
Miscellaneous				
	PS-400/PL-4 A-P Output Board	Q42452-5	1	Fully assembled board

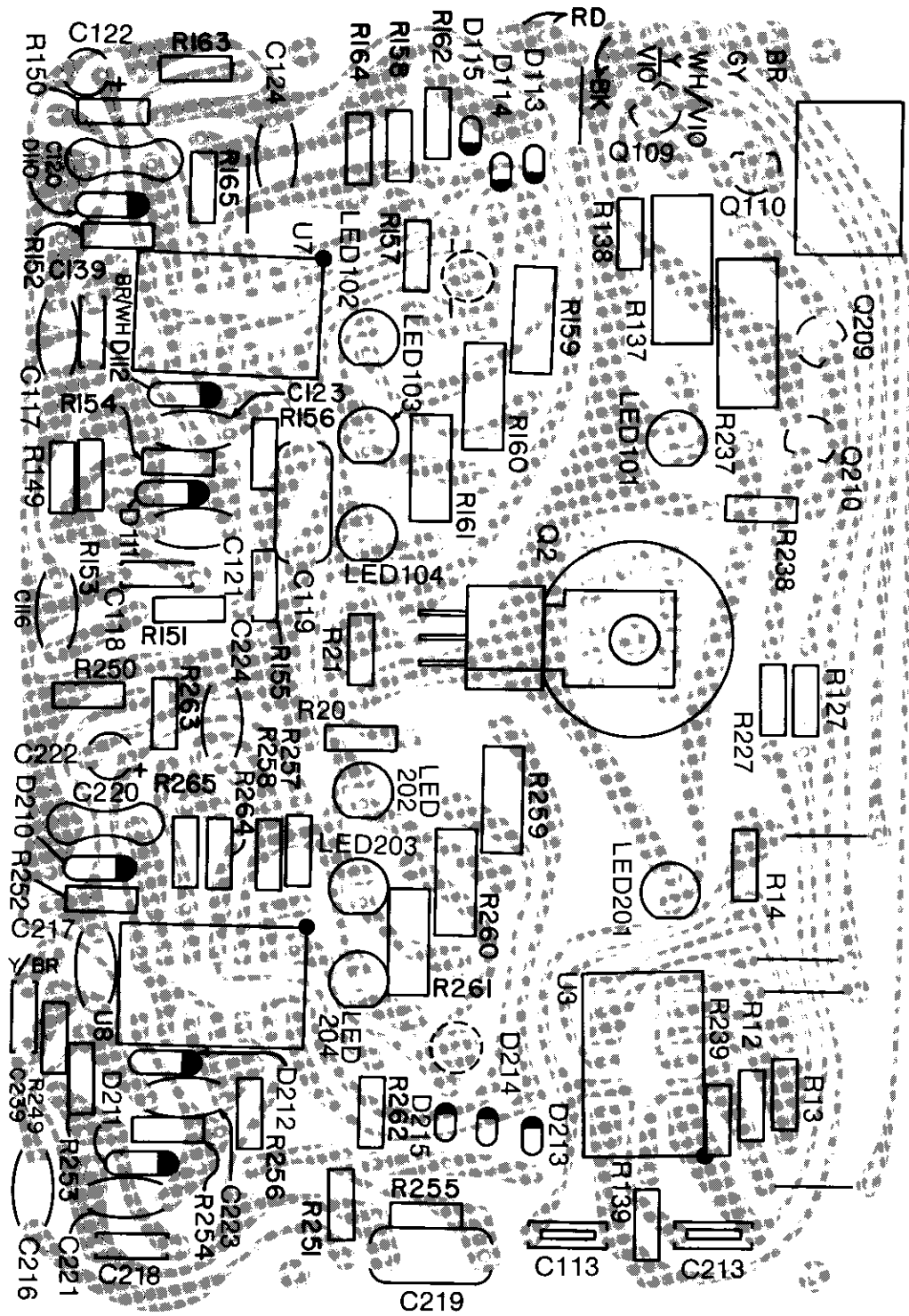

Fig. 6.11 Power Line Four Display Module Component Board Layout; P 9987A0

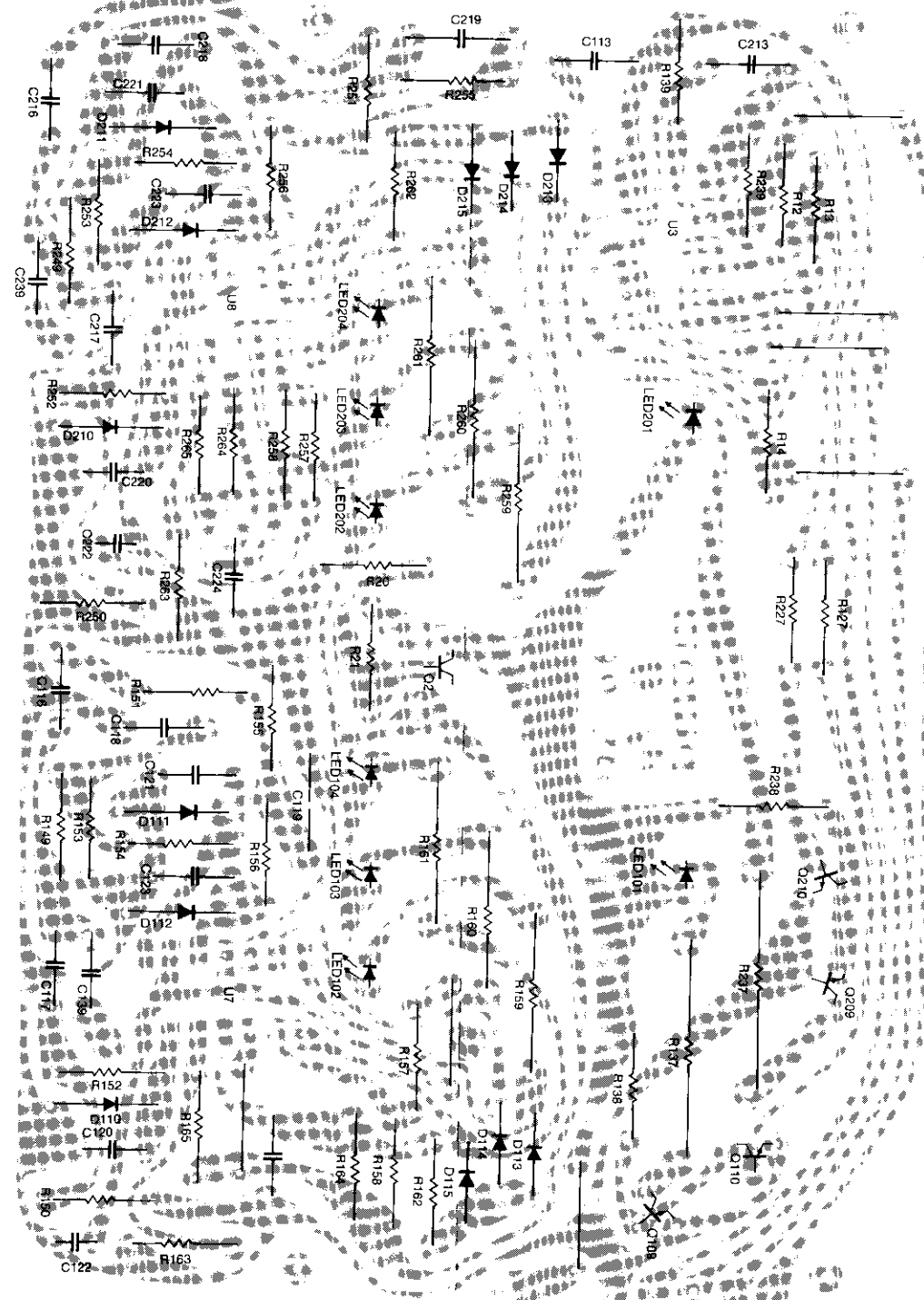

Fig. 6.12 Power Line Four Display Module Foil Board Layout; P 9987A0

Schematic Designation	Description	Crown Part No.	Qty.	Other Information
Resistors				
R12, R14, R20, R21	10K ohm .25W 5%	C 2631-7	4	
R13	68K ohm .25W 5%	C 3620-9	1	
R137, R237	3.3K ohm 1W 5%	C 3617-5	2	
R127, R227	4.7K .25W 5%	C 3939-3	2	
R138, R238, R152, R252, R153, R253, R154, R254, R156, R256, R162, R262	56K ohm .25W 5%	C 2882-6	12	
R139, R239, R149, R249, R163, R263, R164, R264, R165, R265	150K ohm .25W 5%	C 4216-5	10	
R150, R250, R151, R251, R155, R255, R157, R257	20K ohm .25W 5%	C 5046-5	8	
R158, R258	270K ohm .25W 5%	C 2885-9	2	
R159, R259, R160, R260, R161, R261	1.5K ohm .5W 5%	C 1076-6	6	
Capacitors				
C113, C213	0.1mF	C 5639-7	2	
C116, C216, C124, C224	0.01mF	C 1751-4	4	
C117, C217, C121, C221, C123, C223	0.001mF	C 2288-6	6	
C118, C218, C139, C239	0.047mF	C 6075-3	4	
C119, C219	.0039mF	C 4151-4	2	
C120, C220	100pF	C 3447-7	2	
C122, C222	4.7mF	C 4019-3	2	
Diodes				
D110, D210, D111, D211, D112, D212	IN4148	C 3181-2	6	
D113, D213, D114, D214, D115, D215	IN270	C 3447-7	6	
Intergrated Circuits				
U3, U7, U8	LM339 N Volt Comparator	C 4345-2	3	

Schematic Designation	Description	Crown Part No.	Qty.	Other Information
Transistors				
Q2	D40P3	C 5065-5	1	
Q109, Q209, Q110, Q210	SEL 2N3859A	D 2961-7	4	
LED's				
LED101, LED201	T 1 RED LED	C 5905-2	2	
LED102, LED202	T 1 YEL LED	C 5906-0	2	
LED103, LED203	T 1 GRN LED	C 5960-7	2	
LED104, LED204	T 1 AMB LED	C 5904-5	2	
Miscellaneous				
	14 Pin IC Socket Board, Display PL-3/PL-4	C 3450-1 Q42457-4	3 1	Socket for U3, U7, U8 Fully assembled board
	LED mounts 907-475	C 5914-4	2	Use with LED 101, 201
	LED mounts 907-455	C 6065-4	6	Use with LED 101, 201 103, 203, 104, 204

Parts List: PS-400/PL-4 Input Module #P10013-4

Schematic Designation	Description	Crown Part No.	Qty.	Other Information
<i>Parts List: PS-400/PL-4 Input Module #P10013-4</i>				
R101, R201	6.8K ohm .25W 5%	C 5166-1	2	
R102, R202	50K ohm 31 pos. LVLCTL Board, Pot PS/PL Input	D 5686-7 P10013-4	2 2	
<i>Parts List: PS-400/PL-4 Power LED Board #P9981A-3</i>				
R19	4.7K ohm 1 W 10%	C 2807-3	1	
LED 1	MV5153 Amber LED	C 4342-9	1	
	LED mounts 905-380	C 5913-6	1	Use with LED 1
	Board, Power LED PS/PL	M42852-0	1	
<i>Parts List: PS-400 Chassis Mounted Parts</i>				
C2, C3	13,500mF 70V	C 3436-0	2	
T1	Power Transformer	D 5660B8	1	
F1	3AB 10A 1.25 Fuse	C 2819-8	1	
J1	11 Pin Socket Round	C 3910-4	1	
J2	3-140-Y Barrier Block	C 3842-9	1	
J3	2-140-Y Barrier Block	C 3489-9	1	
J101, J201	N112A 2 Cond. Hi-D Jax Output Barrier Block; 4-141-Y #6 Barrier Block	C 33631-6 C 5990-4	2 1	
	Board, Filter PL-4/PS-400	P 9979A7	1	Use with C2, C3; C 3636-0
	2.7 ohm 1 watt comp.	C 1001-4	1	
<i>Parts List: PL-4 Chassis Mounted Parts</i>				
R1	2.7 ohm 2W 10%	C 6046-4	1	
C1	.1mF 200V 10% Film	C 2938-6	1	
C2, C3	13,500mF 70V	C 3436-0	2	
D1	MDA 3502 35A Bridge	C 4305-6	1	
SW1	Switch, Lever 25W SPST NO	C 5699-0	1	
F1	3AB 10A 1.25 Fuse	C 2819-8	1	
T1	Power Transformer	D 5660B8	1	
J102, J202	Dual Binding Post	C 2823-0	2	
	Input Mono Jack; 2 way			
	Phono Jack Right Angle	C 4938-5	1	
	Output Monitor Jack; L112B			
	3 Cond. Hi-D Jax	C 5892-2	1	
	Mono/Stereo Jack; DPDT			
	Flush Bat	C 4992-1	1	
	Board, Filter PL-4/PS-400	P 9979A7	1	Use with C2, C3; C 3436-0

Parts List: PS-400/Power Line Four Front Assembly

Index No.	Schematic Designation	Description	Crown Part No.	Qty.	Other Information
Front Panel Assembly					
1		Front Panel Knobs	D 5714B3	2	
2		PS-400 Front Panel	F10041-6	1	
2A		Power Line Four Front Panel	F10046-5	1	
3		Fiber Shoulder Washer	C 1306-7	1	
4		.37 x 32 Nut	C 5920-1	1	
5		3-32 Mounting Button	C 5893-0	2	
6		Jack Support Bracket	F10045-7	1	
7		Bright Washer	--	1	Part of C 5892-2
8		3 Cond. Phone Jack	C 5892-2	1	Monitor Output
9		Internal Starwasher	C 4822-0	1	
10		8-32 .62 Machine Screw	C 2228-2	1	
11		#8 Internal Starwasher	C 1951-0	1	
12	D1	MDA3502 Bridge	C 4305-6	1	
13		PS-400 Sub Front Panel	M20230-5	1	
13A		Power Line Four Sub Front Panel	M20173-7	1	
14		15" Tie Wraps	C 5894-8	4	Used with C2 and C3
15	C2, C3	13,500 mF 70V	C 3436-0	2	
16		8-32 Hex Nut	C 1986-6	1	
17		806 Solder Lug #10 Hole	D 3312-2	1	
18	R1	2.7 Ohm 1 Watt	C 5862-5	1	
19		10-32 x .50 Machine Screw	C 2049-2	4	
20		#10 Internal Starwasher	C 2279-5	4	
21		Filter Board	P 9979A7	1	
22		Foam Tape	S 2693-0	--	Used with C2, C3
23		Board Supports	C 5895-5	6	
24	T1	Power Transformer	D 5660B8	1	
25		Nylon Spacers	C 5925-0	4	
26		.25 Internal Starwasher	C 2365-2	4	
27		.25 x 20 Hex Nut	C 5919-3	4	
28		Main Board Plate	F10037C8	1	
29		Main Board Module	Q42454-1	1	
30		PC Board Retainer	C 5896-3	2	
31	R102, R202	50K Ohm 31 Pos. Control	D 5686-7	2	Hardware included
32		Lockwasher	C 4822-0	2	
33		Flexible Board Support	C 5897-1	2	
34		Pot Shaft Coupler	C 4888-1	2	
35		8-32 .37 Machine Screw	C 5099-4	2	
36		#8 Internal Starwasher	C 1951-0	2	
37		Post Terminal Board	D 5712A9	1	
38		Control Board Module	Q42453-3	1	
39		Control Board Support Plate	M20174-5	1	
40		6-32 x 1.0 Machine Screw	C 2138-3	2	
41		PC Board Support	C 5055-6	4	
42		4-40 .37 Selftapping Screw	C 5961-5	2	
43		Fishpaper	D 5842-6	2	
44		25A SPST Lever Switch	D 5699-0	1	Power switch
45		6-32 Hex Nut	C 1889-2	2	
46		1 Station Plunger	D 4808A6	1	
47		762 Solder Lug	D 3515-0	1	

Parts List: PS-400/Power Line Four Front Assembly

Index No.	Schematic Designation	Description	Crown Part No.	Qty.	Other Information
48		Snap-on Pushbutton	D 5683A2	1	
49		Side Panels	M20191-9	2	Includes captive nuts
50		8-32 .37 Machine Screw	C 5099-4	4	Two per side panel
51		#8 Internal Starwasher	C 1951-0	4	Two per side panel
52		#10 .37 Sheetmetal Screw	C 4035-9	6	Three per side panel
53		#10 Internal Lockwasher	C 2279-5	6	Three per side panel
54		10-32 Machine Screw	C 5100-0	4	
55		#10 Internal Lockwasher	C 2279-5	4	
56		PS-400 Handle	D 5666-9	2	M20247J8; PS-400 handle assembly
57		PS-400 Rack Handle Angle	D 5670A9	2	
58		6-32 .25 Machine Screw	C 1954-4	2	
59		#6 Internal Starwasher, Black	C 1823-1	2	
60		Power LED Module	Q42451-7	1	
61		Extension Shaft	F10035C2	2	
62		Retainer Ring	C 5918-5	2	
63		Display Module	Q42450-9	1	
64		Rubber Grommet	C 5021-8	4	
65		Steel Washer	C 5917-7	8	
66		.25 Internal Starwasher	C 2365-2	4	
67		Hex Nut	C 5919-3	4	
68		Snap Bushing	C 2412-2	4	
69		Bottom Cover	F10175A0	1	
70		8-32 .37 Machine Screw	C 5099-4	5	
71		#8 Internal Starwasher	C 1951-0	5	
72		10-37 Sheetmetal Screw	C 4035-9	6	
73		#10 Internal Lockwasher	C 2279-5	6	
74		.35 Switch Collar	D 4108-3	1	
75		Metric Shaft Collar	D 5731A9	1	
76		Phone Jack Collar	D 5710A3	1	
77	C1	0.1mF 200V Film	C 2938-6	1	
78		6-32 .12 Hex Screw	C 6035-7	4	

Parts List: PS-400/Power Line Four Back Assembly

Index No.	Schematic Designation	Description	Crown Part No.	Qty.	Other Information
		Rear Panel Assembly			
1		6-32 .62 Screw	D 5844-2	40	
2		#6 Internal Starwasher	C 5594-4	40	
3		MJ15150 PWR NPN	D 5841-8	16	Output Transistors
4		TO-3 Insulator	C 3570-6	20	One per output device
5		Heat Sink Extrusion	D 5662-8	2	
6		Output Module	Q42452-5	2	
7		Top Cover	F10175K8	1	
8		#10 .37 Sheetmetal Screw	C 4035-9	7	
9		#10 Internal Lockwasher	C 2279-5	7	
10		8-32 .37 Machine Screw	C 5099-4	5	
11		#8 Internal Starwasher	C 1951-0	5	
12		Transistor Cover Slides	F10040J7	4	
13		DPDT Slide Switch	C 4992-1	1	Mono/Stereo Switch
14		PS-400 Rear Panel	M20172-9	1	
14A		Power Line Four Rear Panel	F10047J2	1	
15		505 Solder Lug #6 Hole	C 3163-0	1	
16		6-32 Hex Nut	C 1889-2	1	
17		8-32 Hex Nut	C 1986-6	4	
18		#8 Internal Starwasher	C 1951-0	4	
19		Dual Binding Post	C 2823-0	2	Output jacks
20		#10 Internal Starwasher	C 2279-5	6	
21		#10 .37 Sheetmetal Screw	C 4035-9	6	
22		4 Terminal Barrier Block	C 5990-4	1	Output terminals
23		6-32 .25 Machine Screw	C 1954-4	2	
24		#6 Internal Starwasher	C 1823-1	2	
25		2 Cond. 1/4" Phone Jack	C 3631-6	2	Unbalanced input jacks; includes mounting hardware
26		11 Pin Round Socket	C 3910-4	1	Accessory receptacle
27		Screw Slot Fuse Holder	C 5597A5	1	
28		PS-400 Power Cord	H42520-9	1	
28A		Power Line Four Power Cord	H42479-8	1	
29		Strain Relief	C 3582-1	1	
30		8-32 .87 Machine Screw	C 4252-0	4	
31		6-32 .25 Machine Screw	C 1954-4	1	
32		#6 Internal Starwasher	C 1823-1	1	
33		2 Terminal Barrier Block	C 3489-9	1	Ground strip
34		#6 Internal Starwasher	C 1823-1	4	
35		6-32 .50 Machine Screw	C 2176-3	4	
36		Barrier Block Jumper	C 4726-3	1	
37		3 Terminal Barrier Block	C 3842-9	1	Input barrier strip
38		2 Way Pin Jack Strip	C 4933-5	1	Power Line Four input jacks
39		.37 Hex Head Screw	C 4895-6	2	

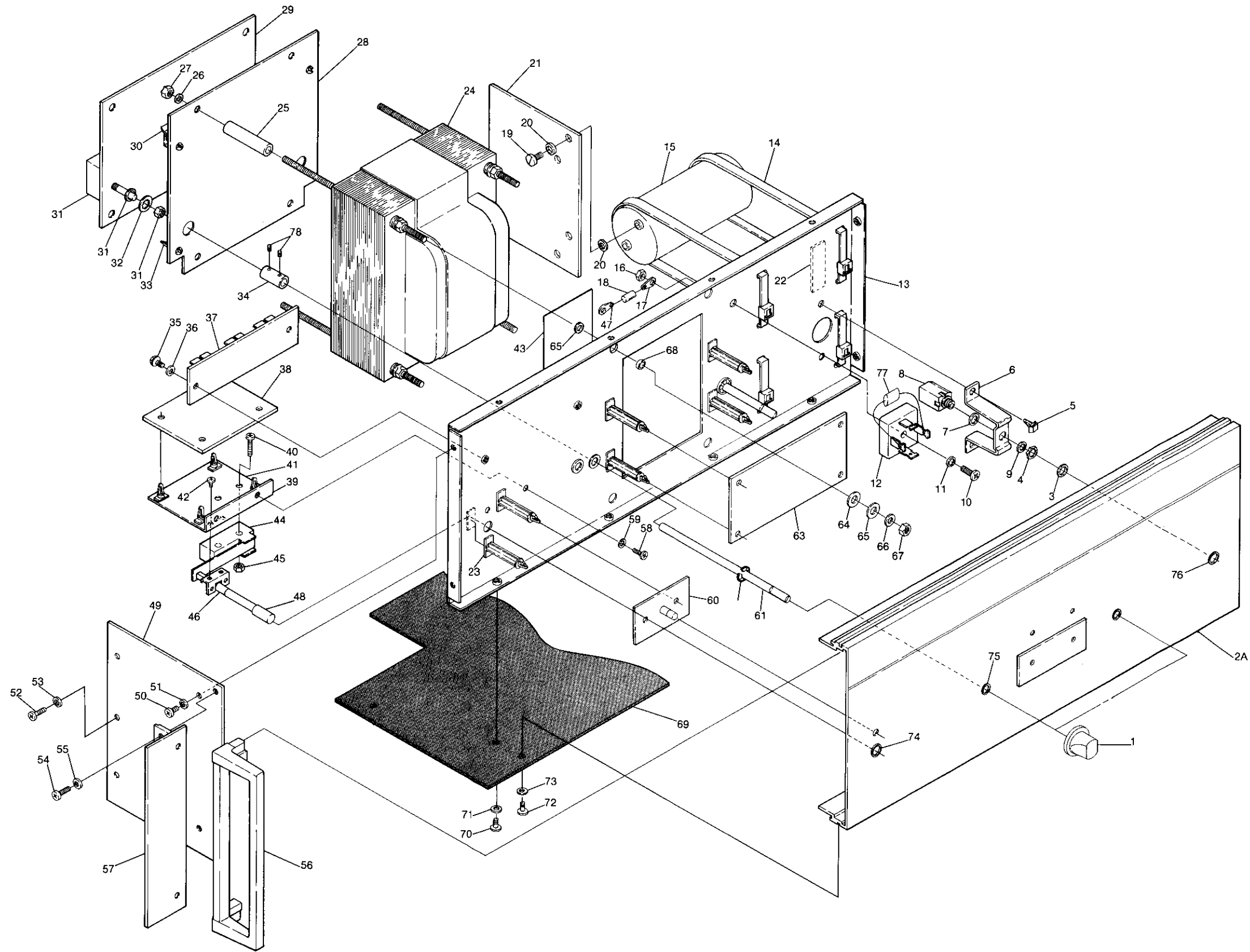

Fig. 6.13 PS-400/Power Line Four Front Chassis Assembly

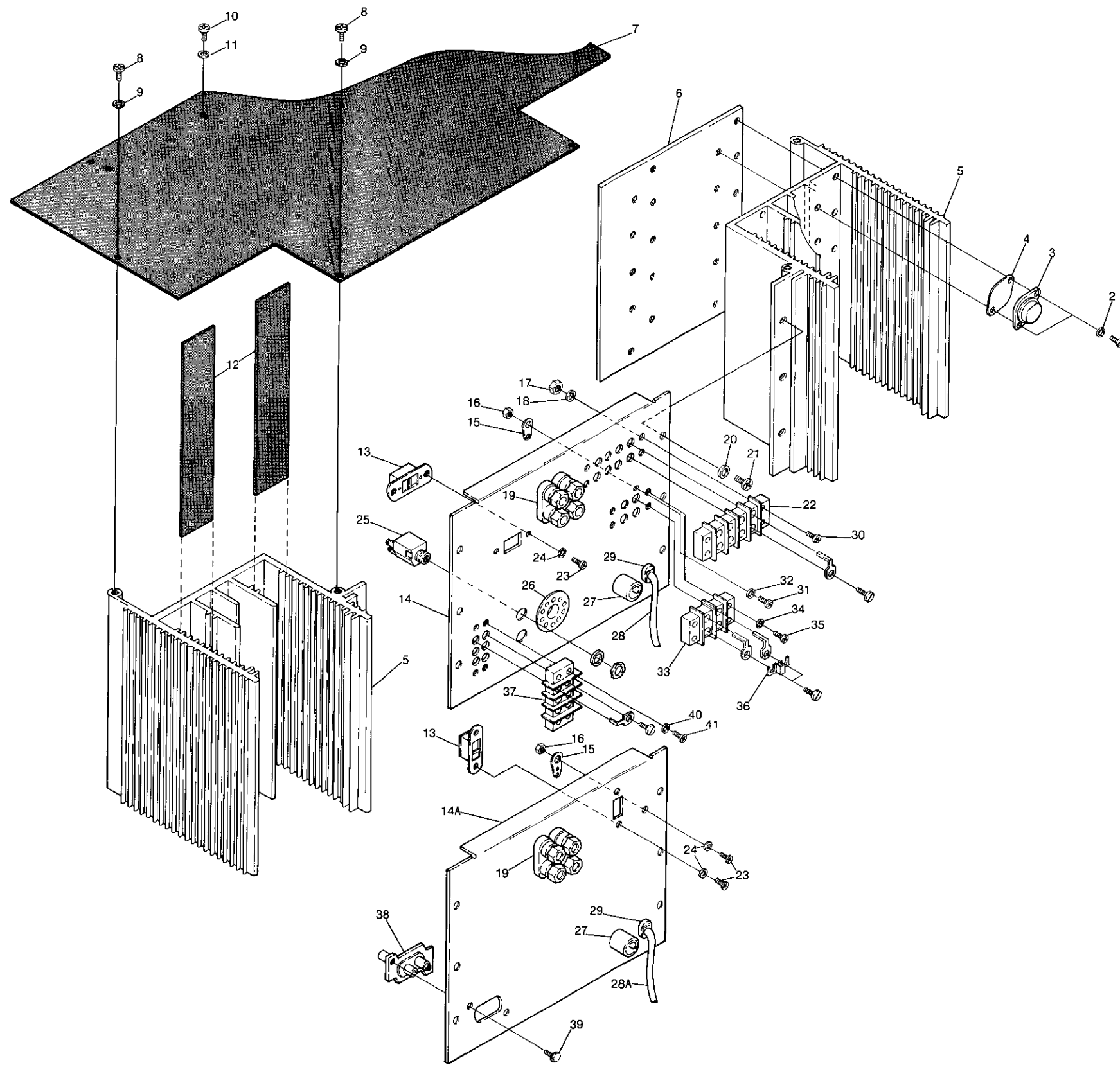

Fig. 6.14 PS-400/Power Line Four Back Chassis Assembly



SECTION 7 MAINTENANCE

7.1 Introduction

Section 7 contains technical information required to effectively and efficiently service and repair the Crown PS-400/Power Line Four. Included are disassembly and reassembly procedures, required test equipment lists, checkout procedures, basic troubleshooting tips and a soldering technique review.

THIS INFORMATION IS INTENDED FOR USE BY AN EXPERIENCED TECHNICIAN ONLY!

Use this information in conjunction with the Instruction Manual, schematic/board layout diagrams, parts lists

and exploded view drawings (the latter located in Section 6 of this manual).

7.2 Required Test Equipment

Many of the service and repair problems with the PS-400/Power Line Four can be performed with a limited amount of test equipment. However, in order to return the unit to its "factory new" specifications, the following list of required test equipment is recommended. The "Requirements" column provides information to allow intelligent selection of substitutes if the "Suggested Supplier and Model" is not available or is considered impractical to obtain.

Equipment	Requirements	Application	Suggested Model
Oscilloscope	Capable of displaying a 10MHz signal	Monitoring output during service and testing	Telequipment D54A or equivalent
Volt-ohmmeter (DVM)	Low-voltage resistance probe (100mv range). High-voltage resistance probe (1.5V range)	Check resistance values (low voltage probe). check semiconductor junctions for opens or shorts (high voltage probe) Check DC voltages	Fluke 8021B or equivalent
Freq. Counter		For accurate general monitoring	Heath SM118A
Signal Generator	Sine/Square wave available; flat frequency response. THD. .1% maximum	Provide test signals for service and checkout	Wavetek 130-Series or equivalent
Circuit Breaker	15 ampere rating	In AC line to unit; protects circuitry from overload if power supply has shorted	
AC Line Voltage Monitor	Peak reading meter (displays rms equivalent to a sinusoidal peak from any wave form)	Monitor Line voltage	Available from Crown

Equipment	Requirements	Application	Suggested Model
AC Voltmeter	100mv low range, flat frequency response to 100KHz	Set output level for testing; check noise level	Hewlett-Packard 400F or equivalent
Filter	20-20KHz bandpass, low noise 20Hz-20KHz	Between preamplifier and voltmeter in noise test	Information available from Crown
Intermodulation Distortion Analyzer	Residual (.002% or lower)	Check IM distortion	Information available from Crown

7.3 Basic Troubleshooting

As is well known, time is an important factor in providing efficient service repair. Therefore, several time-saving troubleshooting steps are listed below. These hints may or may not already be implemented in your service work. If not, you may wish to experiment with them in order to help improve your efficiency. After all, time is money!

A. Establishing Problems

User complaints about defective operation may not always be clear or simple. Furthermore, the trouble the user has experienced may be due to the system and not the unit itself. If possible, talk to the user about this problem. This will usually be simpler than trying to understand written complaints. A first hand account of the problem can help in:

- 1) Getting the problem to re-occur on the service bench.
- 2) Getting an understanding of the probable cause. Some troubles will be obvious upon visual inspection. When the trouble (or its symptoms) is not so obvious ask:
 - a) Exactly what was the problem; how was it noticeable?
 - b) How was the unit being used?
 - c) Has the system as a whole been carefully examined for possible external problems?
 - d) How long had the unit been operating when the problem occurred? Was it heat related?

If the user is unavailable or unable to explain the trouble the next step is a thorough visual inspection.

B. Visual Inspection

A good visual inspection may often save hours of tedious troubleshooting. Make a habit of proceeding in an orderly manner to insure that no vital part of the following procedure is omitted. The visual inspection can be performed in 10 to 15 minutes. It is recommended both as a preventive maintenance procedure and also for its value in determining cause of malfunction.

- 1) Check that all external screws are tight and that none are missing.
- 2) Check all fuses/circuit breakers.
- 3) Check for smooth and proper operation of switches, etc.
- 4) Inspect line cord for possible damage to cap, jacket and conductors.
- 5) Remove protective covers as outlined in disassembly instruction (Section 7.5).
- 6) Check that all attaching parts for internal circuits are tight and that none are missing.
- 7) Inspect all wiring for charred insulation, or discoloration as evidence of previous overheating.
- 8) Check that all electrical connections are secure. This includes wire terminals, screw and stud type terminals, and all soldered connections.
- 9) Check for obvious destruction of internal structural parts. Distortion in any of these parts could mean that the unit has been dropped or subjected to severe shock.

7.4 Discharging Instructions

Both the PS-400 and the Power Line Four amplifiers incorporate very large storage capacitors in the power supply (C2 and C3). For this reason, at any time the covers of the unit are removed, it is necessary to discharge the power supply capacitors. This is done in order to avoid possible damage to the unit and also to prevent shock hazard. The recommended method of discharging is to place a 50 ohm/10 watt resistor across the + and - terminals of each capacitor for several seconds. Use caution when handling the discharge resistor, particularly avoiding skin contact with the leads during actual discharging.

7.5 Disassembly for Inspection, Service, Testing, Adjustment and Repairs

The extent of disassembly will depend on the amount of inspection, service, testing, adjustment and repair to be performed on the PS-400/Power Line Four amplifiers. Both units have been designed for ease of service. Most every component part is easily accessible, particularly



after board module removal. In most cases it will never be necessary to replace a board module entirely unless damage has occurred beyond repair (severed, burnt, etc.). Board module and select assembly removal instructions are listed below in the event repair procedures become necessary. Illustrations referred to in parenthesis are located in the parts list (Section 6) of this manual. R refers to the rear panel assembly drawing while F refers to the front panel assembly drawing.

A. Cover Removal

A fairly complete visual inspection can be performed by removing the top (7R) and bottom (69F) covers. To remove these parts, proceed as follows:

1. Remove the twelve phillips head mounting screws (8, 10R) and washers (9, 11R) that secure the top cover (7R). Gently lift the cover and remove.
2. Remove the twelve phillips head mounting screws (70, 72F) and washers (71, 73F) that secure the bottom cover (69F). As with the top cover, the bottom cover can now easily be removed.

Warning: Immediately after removing the bottom cover as previously described, discharge the two large power supply capacitors according to the instructions in Section 7.4. Failure to heed this warning could result in serious shock or damage to circuit components.

B. Main Board Module Removal

1. Remove the top (7R) and bottom (69F) covers as described in Section A.
2. Remove the six phillips head screws (21R) and internal star washers (20R) that secure the rear panel (14R).
3. Slide the rear panel to the extreme left, far enough to allow the right side of the panel to clear its mounting slot.
4. The rear panel will now be free to drop down, as far as the connecting wires will allow, exposing the Main board (29F).
5. In order for the Main board to be removed from its mounting position, it will be necessary to loosen the Input Level control shaft couplings (34F). Use an appropriate size allen driver to loosen the coupling set screw located closest to the main board. This action will free the shaft of R102 and R202 from the coupling. After this is done, gently lift up on the two release

tabs of the Main board support brackets (30F) (one located in each of the upper left and right hand corners of the Main Board), and pull the board away from the mounting pegs with equal pressure applied to the edges while doing so.

Note: When performing the above procedures in reverse for reassembly, be sure to align the shaft coupling so that the front panel knob is positioned the same as it was prior to loosening.

6. The above listed procedures will allow access to most of the components parts located on the Main board. However should complete removal from the unit be required, it will be necessary to disconnect each wire soldered to it. For proper wire placement upon reconnection, note the Main component board layout (Fig. 6.4) and the hard-wiring diagram in Fig. 6.21.

C. Display/LED Board Removal (also includes bridge rectifier block and Output Monitor jack removal)

1. Remove the top (7R) and bottom (69F) covers as described in Section A.
2. Remove the front panel knobs (1) by grasping them firmly and pulling straight backward, away from the front panel.
3. Remove the four (two on each side of the unit) phillips head mounting screws (54F) and internal starwashers (55F) that mount the front panel (2F) to the side panels (49F). With a grip on each handle (56F), gently pull the front panel straight back away from the unit. This procedure exposes the Display board (63F), the LED board (60F), the bridge rectifier block (12F), Output Monitor jack (8F) and Input Level control extension shafts (61F).
4. The Display board can now be easily removed from its mounting pegs (23F) by squeezing the small release levers of each, and pulling the board straight out, away from the chassis sub-front (13F). If complete removal is necessary, unsolder the ten multi-colored wires, noting their location for future reconnection. The Display component board layouts for both the PS-400 and the Power Line Four (Fig. 6.11 and 6.13) and hard-wiring diagram (Fig. 6.21) are provided as additional aid for reconnection.
5. Like the Display board, the LED board (60F) is removed from its mounting pegs (23F) by squeezing the release levers so as to allow for the board to be pulled away from the chassis subfront (13F).

D. Control Module Removal

1. Remove the top (7F) cover as described in Section A.
2. Locate the Control Module (38F) at the front left of the unit. In order to obtain adequate access to this board, it will be necessary to remove the left side panel (49F). This is accomplished by removing seven phillips head screws (50F, 52F, 54F) and their respective internal starwashers (51F, 53F, 55F).
3. Squeeze the release levers of each mounting peg (41F) and pull the board upward, away from its mounting plate (39F).
4. For complete removal from the unit, disconnect the 21 multi-colored wires soldered to it, noting their location for future reconnection. For assistance in reconnection, refer to the component board layout (Fig. 6.6) or the hard-wiring diagram (Fig. 6.21).

E. Output Module Removal (includes output transistor replacement)

1. Remove the top (7R) and bottom (69F) covers as described in Section A.
2. For easiest access to the output boards, detach the entire heat sink assembly by removing the 3 phillips head mounting screws on the rear panel (21R) and the three mounting screws on the side panel (52F).
3. Remove the output transistor cover panels (12R) by sliding them up and out of their slots, via the top of the heat sink assembly. If necessary, remove all four of the cover panels (two per heatsink).
4. The Output boards are secured in place by the 6 transistor phillips head mounting screws (1R). If replacing the entire board it will be necessary to unsolder each transistor as well as remove all 6 mounting screws. Next, disconnect all wires associated with this board noting their original location for future reconnection. Also note the hard wiring diagram (Fig. 6.21) for additional assistance. When replacing the module make sure to generously apply thermally conductive grease between the thermal sensor transistor (Q111 and Q211) and the output heatsink. The same technique applies to replacing the bias servo transistor (Q129 and Q229) and the output heatsink. In some models the grease was replaced with super glue.
5. For individual output transistor replacement, unsolder the two leads of the specific device and remove its two phillips head mounting screws (1R) and starwashers (2R). When remounting with a new transistor, be sure to apply heat-sink compound for proper heat transfer.

Note: Do not use excessive torque when tightening the transistor mounting screws (6-8 in/lbs recommended). Too much pressure may cause damage to the foil traces of the Output module.

F. Power Supply Capacitor Replacement (C2 and C3)

Warning: C2 and C3 are very large storage capacitors. Always discharge both when working in or around this circuitry, according to the instructions in Section 7.4.

1. Remove the top (7R) and bottom (69F) covers as described in Section A, and the front panel (2F) as described in Section C, steps 2 and 3.
2. Remove the phillips head screw (10F) that supports the bridge rectifier block. This process relieves the nut (16F) and solder lug (17F) that is attached to R1 which in turn, is attached to the capacitor board (21F).
3. Remove the right side panel (not shown; opposite 49F) held in place by 7 phillips head screws (50F, 52F, 54F) and star washers (51F, 53F, 55F.).
4. Remove the Output Monitor jack (8F) and related hardware from its mounting stand (6F) and slide it through the large hole in the chassis subfront (13F). Move the wire and jack away from the capacitor assembly as much as possible so as not to interfere while working with the assembly.
5. With a pair of diagonal cutters, snip each of the four heavy-duty tie wraps (14F) which support the capacitors. The capacitor assembly should now be free enough to slide sideways providing the needed access to the capacitor screw terminals.
6. For complete removal of the entire assembly, disconnect the wires soldered to the board, noting their location for future connection. A hard-wiring diagram is supplied for additional assistance with proper hook-up.

G. Power Transformer Removal

Power transformer (24F) failure is highly unlikely in the PS-400/Power Line Four power amplifiers. However, in the event that this situation does occur, refer replacement to the Crown factory Service Department.

H. Rear Panel Component Parts Replacement

1. Remove the top (7R) and bottom (69F) covers as described in Section A.
2. Follow the procedures listed in Section B, steps 2, 3 and 4.
3. Every component part located on the rear panel is now easily accessible and may be removed/repaired if necessary.

7.6 Reassembly

Reassembly is essentially the reverse of disassembly. If in doubt about types and sizes of attaching parts, refer to the appropriate illustration in Section 6.



7.7 Repair Instructions

Repair of the unit includes replacement of component parts (both on and off board modules), damaged wiring and replacement of any structural parts such as panels and brackets. All replaceable parts are listed in the board layout/parts lists or in the exploded view drawings in Section 6.

Fig. 6.21 shows all amplifier wiring connections including color code, should it become necessary for wire replacement.

Consumable materials (except wire) required in repairing the amplifier are listed in Fig. 7.17. The use of these materials is explained in the last column entitled "Use".

Name	Crown Part No.	Total Unit Qty.	Use
.125 Shrink Tube	B 1353-0	6"	With PS-400; provides insulation for octal socket on rear panel
.042 Black Tube	B 1363-9	2"	Used on output module capacitors
.750 Black Shrink Tube	B 5496-3	2.25"	Provides insulation for fuse holder
#15 PVC Tubing	B 5500-2	14"	Used on torroid coils
Type 340 Heat Sink Compound	S 2162-4	--	Mounting output transistors and drivers on output modules
Solder (63% tin, 37% lead, rosin core)	S 3482-7	--	Soldering electrical connectors in wiring and on printed circuit boards

7.8 PS-400/Power Line Four Electrical Checkout and Adjustment

The following instructions outline an orderly checkout and adjustment procedure for the PS-400 and Power Line Four amplifiers. The test equipment required to perform the various procedures is listed in Section 7.2.

Warning: Most adjustments are made with protective covers removed. This means prior to any non-AC powered testing, discharge both power capacitors, C2 and C3 (see Discharge Instructions, Section 7.4). Use extreme caution while making any internal adjustments when the unit is powered.

Type of Test/Adjustment	Input Signal Characteristics	Comments
1. Turn-on; Four Second Delay	None	a. With the power switch in the OFF (out) position, connect the required input line power and check accuracy with a digital voltmeter. Turn the unit on and then off again while listening for the "click" of the relay becoming activated. This process should take about four seconds each time the unit is turned on. Also note the illumination of the IOC indicator lights; they should remain on during the four second delay period.

Type of Test/Adjustment	Input Signal Characteristics	Comments
2. DC Output Offset	None	With the input level controls (R102 and R202) turned fully counter-clockwise, adjust the output offset adjustment pots, R108 and R208 on the Main board, for a DC voltage of +5mV at the output of each channel.
3. Input Offset Adjustment	None	With the input level controls (R102 and R202) turned fully clockwise, adjust the input offset adjustment pots, R104 and R204 on the Main Board, for a DC voltage of +5mV at the output of each channel.
4. Bias	None	Measure the bias voltage across R172 and R272 located on the Output board. If it does not measure 430mV (+ and -20mV), re-adjust the bias controls R124 and R224. Note: Earlier version amplifiers used fixed resistors for R124 and R224 rather than variable resistors. Typical resistor values are around 150 ohms, varying somewhat with bias voltage readings.
5. Temperature Threshold Adjust	None	<p>Measure the voltage on pin 10 of U4 (located on the Control board) with a digital voltmeter. Also note the table in Fig. 7.18. It shows the proper voltage reading that should be observed with the various thermal transistors (Q111) used in the PS-400/Power Line Four amplifiers. Match the number appearing on the transistor (or on the internal label) with the number in the left-hand column. The correct voltage reading for the above mentioned adjustment is shown next to this number in the right-hand column.</p> <p>Note: If replacement of thermal transistor Q111 or Q211 becomes necessary, be sure to replace both devices, even if only one is faulty. They need not be replaced with the same identification numbers used previously, but must match one channel with the other.</p>

VBE	VMSET	VBE	VM SET	VBE	VM SET
581	468	595	484	607	498
582	469	596	485	608	499
583	470	597	486	609	500
584	471	598	487	610	501
585	472	599	489	611	503
586	473	600	490	612	504
587	475	601	491	613	505
588	476	602	492	614	506
589	477	603	493	615	507
590	478	604	494	616	508
591	479	605	495	617	509
592	480	606	497	618	511
593	482			619	512
594	483			620	513

Fig. 7.1 Thermal Transistor Voltage Table

Type of Test/Adjustment	Input Signal Characteristics	Comments
6. Power Response (at 120 VAC)	a. 1KHz sine wave, 2V RMS; 8 ohm load	a. 37.9 VAC minimum should be obtainable before clip from each channel.
	b. 1KHz sine wave, 2V RMS; 4 ohm load	b. 36 VAC minimum should be obtainable before clip (Fig. 7.19) from each channel.
	c. 20KHz sine wave, 2V RMS; 8 ohm load	c. 36.3 VAC minimum should be obtainable before clip from each channel. Waveform should appear as in Fig. 7.20 with no aberrations due to slewing distortion.
	d. 10KHz square wave, 2V RMS; 8 ohm load	d. 30V RMS should be obtainable before clip from each channel. Waveform should appear as in Fig. 7.21 with no aberrations (overshoot or ringing).

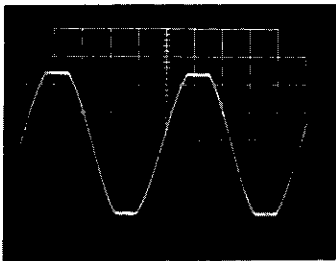

Fig. 7.2 Clipped Waveform

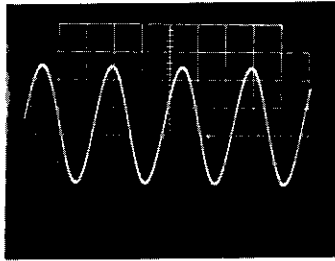

Fig. 7.3 20KHz Sine Wave Response 8 ohms

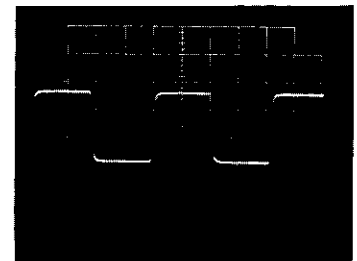

Fig. 7.4 10KHz Square Wave Response, 8 ohms

7. Protection	1KHz sine wave, 2V RMS; 2 ohm with and without inductive (159uh) load.	20V RMS should be obtainable from each channel before clip. With an inductive load added, the waveform should look as in Fig. 7.22 without any distortion evident.
---------------	--	--

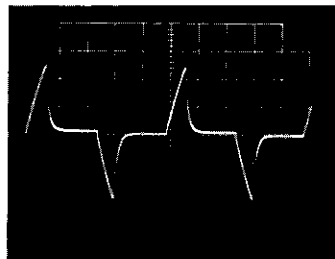

Fig. 7.5 Inductive Load Waveform, 2 ohms

Type of Test/Adjustment	Input Signal Characteristics	Comments
8. Mono Operation	1KHz sine wave, 2V RMS; no load	Using only channel 1 for an input signal, apply signal with mono/stereo switch in the MONO position. Observe the output signal simultaneously of both red or "hot" terminals of both channels. They should be 180 degrees out of phase as shown Fig. 7.23.

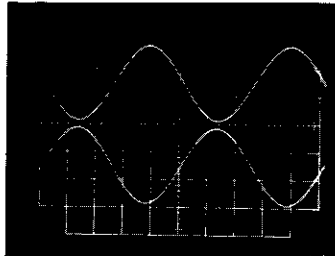

Fig. 7.6 Mono Response Waveform

9. Low Frequency Interrupt	1KHz to 1Hz sine wave, 2V RMS	Adjust the amplifier for a 20V RMS output signal. While observing the IOC indicators, sweep the frequency of the input signal down to 1Hz. Note around 5Hz that they will illuminate. Also observe the four second sampling rate of the LFI circuitry, which automatically resets above 5Hz.
10. Display (PS-400)	1KHz sine wave, variable input level; no load	Increase the input level until the green Signal Presence indicators illuminate. The voltage level should be approximately one volt peak at the output. Connect an oscilloscope to the amplifier output. Again, raise the input level to the point just before clipping is observed. Note the IOC indicators; they should illuminate prior to the visible clipping point on the scope.
11. Display (Power Line Four)	Variable Frequency, sine wave variable level, no load	<ul style="list-style-type: none"> a. Vary the input signal from 10Hz to 200Hz. Yellow, Low Frequency indicators should illuminate at an output level of 100mV. b. Vary the input signal from 100Hz to 4KHz. Green, Mid Frequency indicators should illuminate at an output level of 100mV. c. Vary the input signal from 2KHz to 20KHz. Orange, High Frequency indicators should illuminate at an output level of 100mV.
12. IM Distortion	60Hz/7KHz signal summed in a 4:1 ration (see Fig. 7.24 for hook-up); 8 ohm load	Using a Crown IMA, readings should be less than .004% from 0 to -25dB, less than .010% from -10dB to -25dB and less than .030% from -30dB to -35dB.
13. Signal to Noise	1K input terminator; R104 at both fully CW and CCW; (see Fig. 7.25 for hookup).	With a sensitive ACVM, output signal should be at least 115dB below rated output power. Check with Input Level controls both fully clockwise and fully counter clockwise. Be sure to use a 20Hz-20KHz bandpass filter ahead of the voltmeter.
14. Quiescent Power	None	The quiescent power of the unit should be approximately 40 watts.



7.9 Voltage Conversion Instructions

Often Crown products are purchased in one country and then later moved to another requiring an AC mains conversion. For this reason, the following procedures and chart as well as a world-wide voltage map is provided.

The PS-400/Power Line Four may operate from five different voltages if so desired; they are 100, 120, 200, 220 and 240 volts.

Note: In order to change the voltage, it is first necessary to disconnect power and remove the top cover from the

unit. The main supplies often remain charged for several hours. For this reason, always discharge the large power capacitors according to the instructions in Section 7.4.

The voltage connections are made with push-on connectors and terminal strips. After the correct operating voltage has been chosen, and all of the primary leads have been identified, the conversion can be performed by following the connect drawing located in Fig. 7.26. Be sure to make all necessary fuse changes, if needed. A 10 amp fuse should be used on 100 and 120 volt conversions and a 5 amp fuse on 200, 220 and 240 volts.

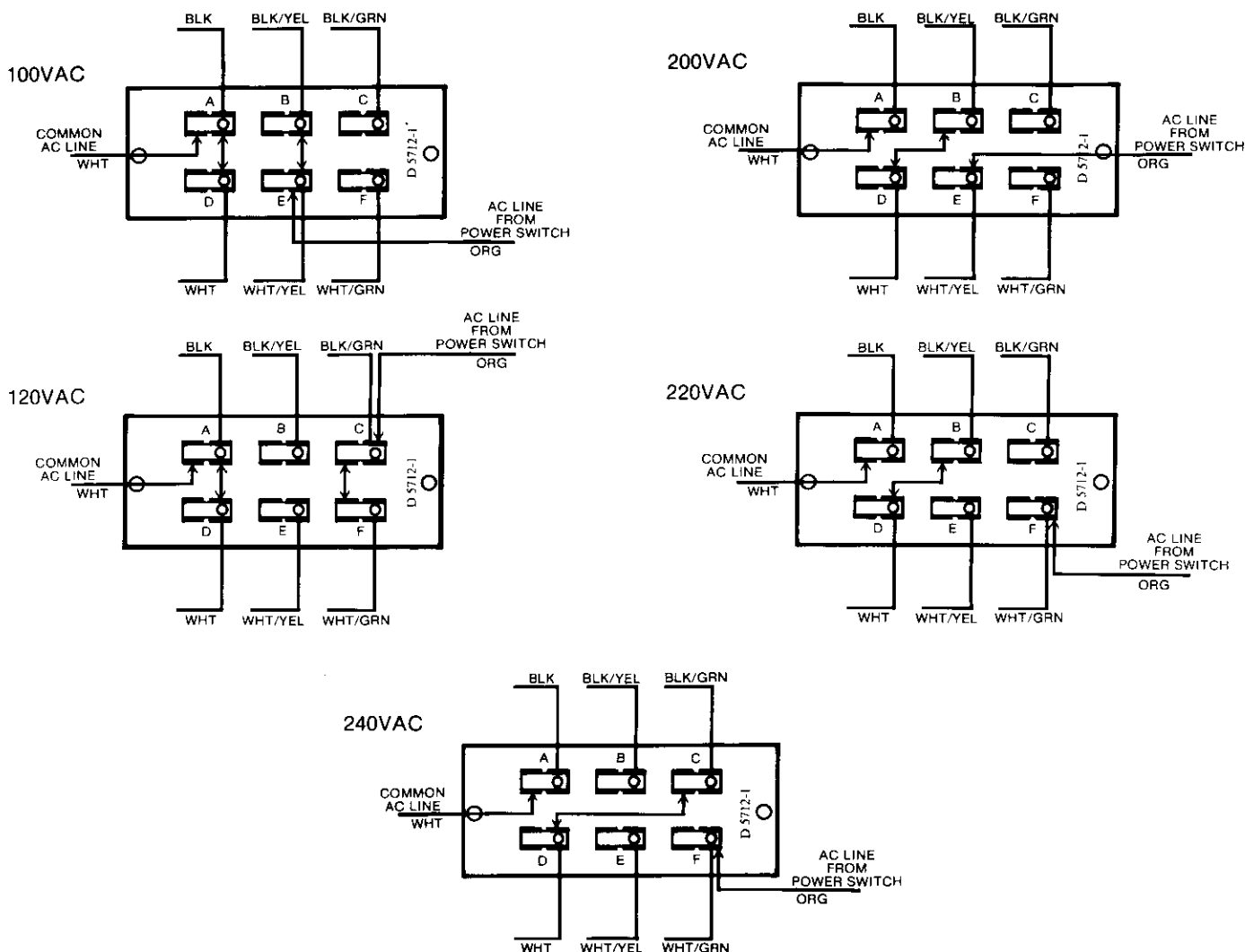

Fig. 7.7 Voltage Conversion Connect Drawing

7.10 PS-400/Power Line Four Detailed Circuit Theory

The following discussion refers to the schematic diagrams located in Section 6 of this manual and the block diagram in Fig. 7.27. In most cases only channel one is referred to for simplicity. Because there are several significant circuit differences between the Power Line Four and the PS-400, certain paragraphs have been separated into sections applicable to each amplifier.

A. Input Stage (without optional balanced input)

The input signal enters the PS-400 through either the ¼" unbalanced phone jacks or the 4 terminal barrier block. The Power Line Four however, has only one choice of input connectors, that being in the form of standard pin jacks. Regardless of the unit, the signal travels first to the front panel Input Level control (R102), a 50K ohm linear taper potentiometer. Because the ear responds more naturally to logarithmic changes in audio level rather than linear changes, R101 acts to alter the response characteristics of R102 for a more logarithmic-type result.

To lessen the opportunity for annoying RF signals to enter the front-end, an 800KHz low pass filter consisting of R103 and C101, is encountered next. From there the signal travels to the non-inverting side of the input IC operational amplifier (U1A). Its high quality performance characteristics include a wide bandwidth and very low noise.

Connected to the inverting input of U1A (pin 6), are the components that make up the main feedback loop: R106, R109 and C103. They serve to help determine the gain and frequency response of the amplifier as well as provide a path for the error correction signal as explained below.

The main purpose of op amp U1, is to compare the input signal (appearing on pin 5) to a portion of the output stage signal that is fed back through a feedback path (appearing on pin 6). The result is an "error signal" from the output of U1 (pin 7). This "error signal" deviates from the input signal in such a direction so as to compensate for any non-ideal output device nonlinearities (such as signal clipping, non-ideal output device operation, etc.) in the amplifier. This process forces the output signal to always be "exactly" twenty times the input signal.

It is worth noting at this point, that there are several feedback loops in the PS-400/Power Line Four circuitry, commonly coined Multi-Feedback loop circuitry. These loops are instrumental in determining the high performance characteristics of these amplifiers and will be mentioned throughout this discussion.

C102, a 47pF capacitor also connected to pin 6 of U1, is part of the frequency compensation circuitry used to help in stabilization of the circuit.

To control any variable DC offset that may occur as a result of this stage, output and input offset controls (R104 and R108 respectively) are used as adjustments for obtaining maximum zero DC offset at the output of the amplifier. This is achieved by applying small current signals to both inputs of IC U1. Connected to the inverting input (pin 6), is the output offset control (R108) and R207. Q1 and related components, also send a current signal to U1, through R105 and R104. This signal however, is temperature dependant, tracking the current demand change with respect to the temperature change of U1. This circuit then, compensates for the change in current necessary to maintain a low offset voltage, with respect to change in operating temperature of the unit.

B. Voltage Amplification Stage

The function of the PS-400/Power Line Four voltage amplifier circuitry is, as would be expected, to provide voltage amplification.

R110, R111, R112 and R113 is a voltage divider string, providing a bias voltage ultimately for the Signal Translator transistors Q101 and Q102. In between these two sections however, are the transmission gates U2A and U2B. They serve the purpose of acting as analog switches with the ability to electronically control the signal path. When not activated, the bias voltage generated in the voltage divider string mentioned above, cannot reach the Signal Translator stage. This means all the stages that follow Q101 and Q102 will be dormant, including the path through to the output of the amplifier. This is the basis of operation for the muting circuit used in the turn-on delay, low frequency and thermal protection circuitry which will be explained in more detail later.

An intermediate feedback loop encompassing everything from the Signal Translator stage to the output stage, consists of R115, R121 and C106. R118 and R119 are emitter resistors, helping to stabilize the operating point of the Signal Translator transistors.

The Signal Translator stage (and the Last Voltage Amplifier stage for that matter) is of the push-pull type, providing a convenient method of utilizing the transmission gates. With this design, a "cleaner" power turn-on and turn-off can be expected without any extraneous noises or pops. Other advantages of the push-pull format are its distortion-cancelling properties as well as its ability to develop twice the normally available current to drive the output stage. The complementary signal translator circuitry (Q101 and Q102) develops the "voltage based" input signal into a "current based" signal at its collectors, free from the effects of power supply

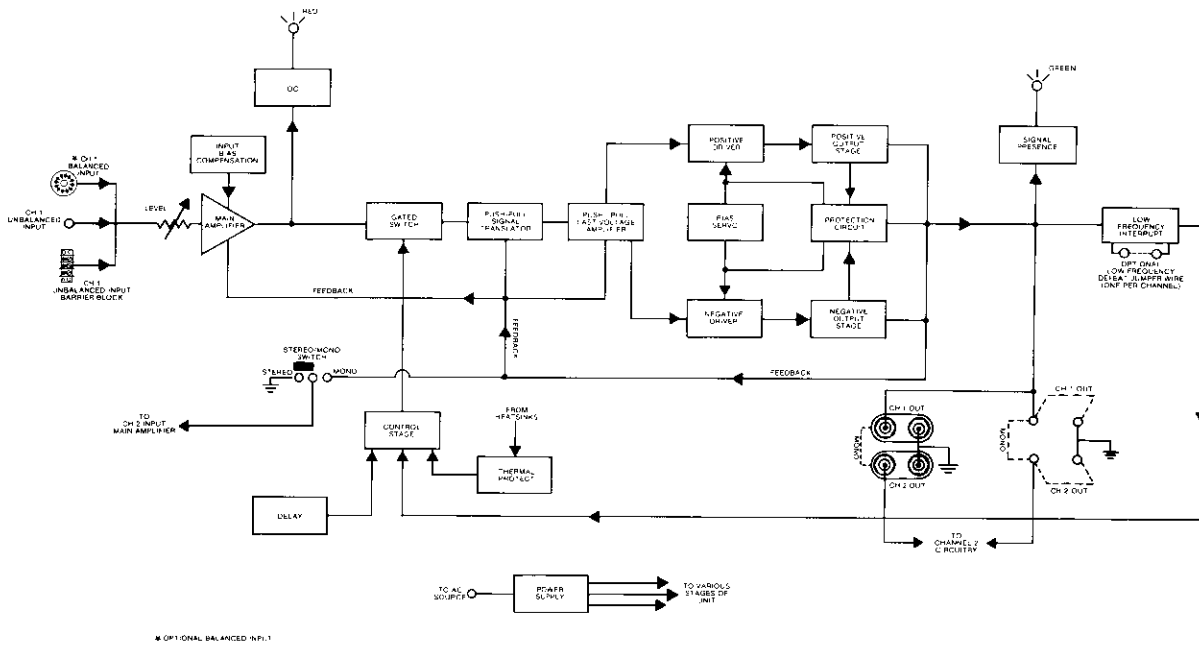

* OPTIONAL BALANCED INPUT

Fig. 7.8 PS-400 Block Diagram

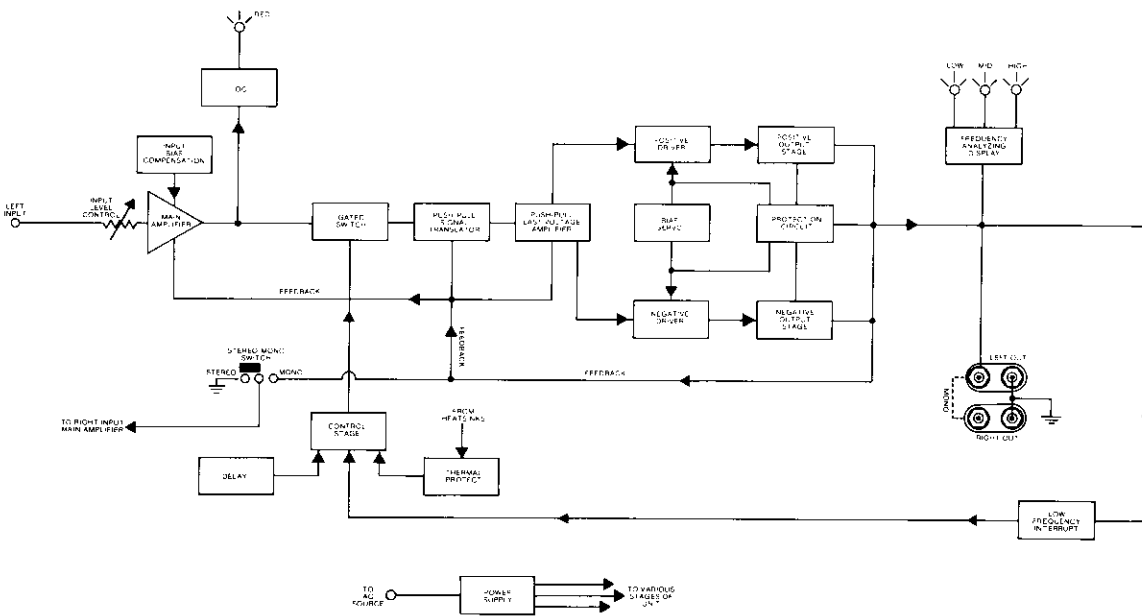

Fig. 7.9 Power Line Four Block Diagram

ripple. At R117 and R120, it is converted back to a voltage and is used to drive the Last Voltage Amplifier stage.

The Last Voltage amplifiers (Q104 and Q106) are the main source of voltage amplification in the unit. As mentioned above, the input signal which is developed across R117 and R120 is the signal fed to the base of Q104 and Q106.

Q103 and Q105 act as current limiting transistors, helping to limit the current to the Last Voltage amplifier transistors when there is potential to exceed the recommended power dissipation level of Q104 and Q106. As the base-emitter voltage developed across R122 and R126 increases beyond its predetermined level (.65V), Q103 and Q105 turn on, shunting or "pulling" the drive signal away from the last voltage amplifier transistors.

C. Output Stage with V-I Protection Circuitry

Basically, the output signal from the Final Voltage Amplifier transistors, provides the drive to the predriver (Q113 and Q114), driver (Q116 and Q117) and output transistor (Q118, Q119, Q120, Q121, Q122, Q123, Q124 and Q125) stages. This output configuration is most commonly referred to as the Crown Multi-mode™ circuit, where at low output signal levels, the circuit functions in the Class A mode (predriver and driver stages biased on), mid levels in the Class A plus B mode (predrivers and drivers operate in Class A while output stage moves smoothly into Class B operation) and at high levels, in Class B (predrivers and drivers operate in Class AB while output stage at Class B). At each level, the Multi-Mode™ circuit offers optimum performance in terms of extremely low distortion and circuit efficiency.

Q112 is a thermally sensitive bias transistor, working to maintain a constant quiescent current through the Driver stage, even when operating temperatures fluctuate. This bias-servo circuit also includes component parts R123, R124, R125 and R166. It operates by controlling the voltage it supplies to the base of the predrivers, as the unit's temperature varies. By doing so, it helps prevent thermal runaway, a condition caused by a change in temperature (usually an increase) which in turn alters (also usually an increase) the current output of silicon devices like those used in this amplifier.

As mentioned previously, Q113 and Q114 are the predriver transistors. Their purpose is to provide the correct "charge" current to the base of the driver transistors when called upon to do so by the front-end stage. It is also necessary during the course of this process to discharge or turn off the driver stage according to the signal polarity requirements. This is accomplished through R169, R170 and Q115. Part of the charge flows out through R169 while the rest across "charge-dumping" transistor Q115, providing a smooth on/off action of the output stage without current spiking.

Capacitors C126 and C127, connected across the predrivers, determine the slew rate limiting point for the maximum frequency that the output stage can tolerate.

Note that all eight of the output transistors are NPN devices, connected in parallel for increased current capability. Emitter resistors R173, R174, R175, R176, R177, R178, R179 and R180, are responsible for stabilizing the operating point in the output stage.

R181, C131, and T103 makeup a terminator circuit providing a load for the output stage at high frequencies. This also helps prevent the possibility of RF signals from entering the amplifier at the output stage.

The V-I protection circuitry is composed of Q107, Q108, R131, R135, R128 and R129. Concentrating mainly on the positive portion of the push-pull section, R131 and R128 form a voltage divider developing a voltage across the base of transistors Q107. Before the output current is allowed to become dangerously high, Q107 is activated, shunting the current away from the predriver transistors. This same theory can be applied to the negative portion (Q108) of the push-pull circuitry as well.

C111 and C112 allow larger peak powers to be handled by the output stages for short periods or "bursts" of time. This is accomplished through a function of the history of the output signal. As the load on the amplifier approaches lower impedance values, C111 and C112 charge in a more positive direction (that is a direction that "sensitizes" the protection circuitry), requiring less voltage to activate Q107 and Q108 as mentioned in the previous paragraph. Conversely, if there appears a higher impedance load at the output, C111 and C112 will charge in a more negative direction, requiring much more current to activate the protection circuit.

D101 and D102 prevent improper flow through this circuit. C109, C110 and R127 help in stabilization of the protection circuit, particularly at low load impedances (2 ohms, etc.) where oscillations could occur.

D. Control Stage

This stage is responsible for three areas of operation: the thermal protection, the low frequency protection and the turn-on delay circuitry. However, because a large majority of the operation of this stage is dependent on the function of the logic circuitry, the discussion will be first focused on this subject.

As mentioned in Section B, transmission gates U2 are the main components responsible for smoothly interrupting the signal path flow to the output stages thus, silencing the amplifier's output. Note connected to pins 12 and 6 of U2 is the output from U5C, a triple input AND gate. By definition, in order for an AND gate to produce a logic "high" output, U5C must receive a logic "high" at all three of its inputs. Because this is a desirable state for U5C during normal operation, all three sections of the



Control stage must be functioning properly and cooperating by sending its logic "high" signal to the appropriate input.

The thermal protection circuit used in the PS-400/ Power Line Four is somewhat different than the circuitry used in earlier Crown amplifiers. Instead of a mechanically controlled thermal switch mounted on the output stage heatsinks, an electronic device (transistor Q111) is used as a replacement. It essentially converts temperature to a calibrated voltage that can be understood by the logic circuitry of the control stage. U4C, a comparator op amp, compares the signal established by the divider network R3, R4 and R5 (fed to pin 4), to the signal from Q111 (fed to pin 5). When the voltage of the signal from Q111 is lower than the threshold voltage established with the wiper of R4, the output of U4C (pin 2) will be logic "low". The reverse is true when Q111 sends a higher signal voltage than that of the threshold point, forcing the output of U4C "high". The latter condition exists during normal operation. Note here that U4D is connected to U4C, helping to provide "hysteresis", a desirable condition in comparator circuits used to prevent sporadic switching which usually promotes oscillations or other circuit instabilities.

The Low Frequency Protection circuitry consists primarily of U6B, an exclusive OR gate and its closely related components. U6B functions under the conditions that when both of its inputs (pins 5 and 6) are logic "high" or if they are both logic "low", then the output (pin 4) will be logic "low". If one input is high and the other input is low, the output will be high. Under normal operating conditions, the output of U6B will be high, meeting the criteria established by U5C described earlier. For example, if no DC or low frequency information is detected at the input of U6B, the voltage potential on pin 5 will be more positive than that of the voltage on pin 6. This is due to the voltage divider networks R145, R147 and R146, R148 connected to the + and - Vcc supplies. With the difference of potential now across the input of U6B, the output will be logic high and the conditions for normal operation (from the standpoint of low frequency protection) will have been met. However, should a DC voltage exist at the input, both pin 5 and pin 6 will appear as logic high, forcing the output at pin 4 to become logic low. With one of the inputs of U5C now low, the output will also be low, shutting down the transmission gates and removing the signal to the output stage.

R144 and C115 determine the roll-off point for the Low Frequency Protect circuitry. It currently activates at DC outputs greater than 10V or low frequency outputs greater than 10V at 2Hz.

Turn-on and turn-off delay is accomplished with U5A, the other third of the 3 input AND gate. C5 and R17 form a timing circuit, responsible for the four second delay upon power-up. When the unit is turned on initially the relay (K1) is energized, removing the short from C5. This in turn allows C5 to slowly become charged from R17. When fully charged, a logic high signal will appear at pin 11 of U5A. Since pin 12 and 13 are tied together to the +9V supply (logic high), the output of U5A (pin 10) will appear high, satisfying the input conditions for U5C. Note at this time that when the output of U6B is low, signifying a low frequency input problem, that it pulls the charge away from C5 through D109. At that moment the output of U5A will go low, causing the transmission gates to remove signal to the output stage. Because the output stage is no longer active, the Low Frequency Protect Circuit does not sense a problem and once again produces a logic high output. Likewise C5 begins to charge and another four seconds later, the output of U5A is high and the amplifier will attempt to return to normal operation. This process will continuously cycle until the low frequency problem is solved. R15, R16, C12 and C13 are decoupling components for the + and - 9 volt supply, providing additional filtering.

E. Power Line Four Display

There are three basic stages in the Display circuitry for the Power Line Four: a low, mid and high frequency stage. Three comparator op amps correlate with the previous statement in that U7A is responsible for the low frequencies, U7B the mid and U7C the high.

R149, C118, R153, R154, D111 and C121 make up the low pass filter where C117, R150, R152, D110 and C120 form the high pass filter. A combination design of the low and high pass filter configuration creates the mid pass section as shown by C116, R151, C119, R155, R156, D112 and C123. All of the signals are fed to their respective comparator's inverting input and passed through to illuminate the proper LED.

Note the remaining components U7D, R162, C124, R163, R165 and R164. They make up a variable threshold circuit, compensating for the change in illumination sensitivity due to the varying output level.

An additional signal from the comparator op amp's output is directed through diodes D113, D114, D115 and R162, to C124. As C124 develops a charge across itself equal to the voltage placed across pin 5 (of U7D) from voltage divider R163 and R165, U7D will turn on causing C122 to begin charging, developing a "set point" voltage connected to the non-inverting inputs of comparators U7A, B and C. With a large amount of output signal activity displayed on the amplifier, C122 will be charged to a very positive potential. This action will move the threshold point of U7A, B and C in an upward direction simultaneously, requiring more voltage to activate the LED's. In an opposite situation where there is a very limited amount of output signal activity displayed, C122 will be charged at a much lower potential requiring less voltage to illuminate the LED's. In either case, the sensitivity of the display circuitry is automatically adjusted for maximum illumination without overload.

Q2 is used as part of a voltage divider circuit along with R20 and R21. It reduces the amount of available voltage from the +Vcc supply to the voltage requirements of the Display circuitry.

F. PS-400 Display

As compared to the Power Line Four Display circuitry, the PS-400 is much simpler in concept and design.

LED 105 is the green Signal Presence Indicator which illuminates at any time the voltage measured at the output stage and applied to the base of Q126 and Q127 reaches 1 or more volts. Both positive and negative signal excursions will be indicated with this full wave detector circuit.

G. IOC (Input Output Comparator)

The IOC display is actually a window comparator circuit using one quad operational amplifier, U3. Any small nonlinearity in the amplifier causes an error in the feedback loop to appear at the output of IC U1. This means the output of U1A (pin 7) will rise above its normal value in an attempt to correct the problem. This "error signal" (as it is called) is responsible for raising the input voltage on U3 and in turn activating Q109 which illuminates LED 101. R139 and C113 form a pulse stretching circuit to hold the LED on for approximately one second so it can be seen, even if the nonlinearity exists for a few microseconds.