

# Accuphase

INTEGRATED STEREO AMPLIFIER E-202



The wooden cabinet is an option.

## Owner's Manual

Thank you for purchasing this Accuphase product, which we here at Ken sonic, who are dedicated to the policy of creating the highest quality audio components, are proud to introduce. You can be assured that in preparing this component, every attention was paid in great detail by our entire staff to strict quality control. This dedication was followed throughout the whole manufacturing process – from basic research, the selection of each part, assembly, testing, data recording, packing and shipping – so that we could supply a product with every confidence that it will give full owner satisfaction and pride.

We welcome you to the fast-growing Accuphase circle of dedicated audio enthusiasts and true sound lovers.

## CONTENTS

SPECIAL FEATURES .....	1
INTERCONNECTION OF COMPONENTS .....	2
PRECAUTIONS BEFORE USING .....	3
PARTS AND THEIR FUNCTIONS .....	4
OPERATING INSTRUCTIONS .....	8
MAINTENANCE .....	10
BLOCK DIAGRAM .....	11
GUARANTY SPECIFICATIONS .....	12
PERFORMANCE CURVES .....	13



# SPECIAL FEATURES

The Accuphase E-202 is a Integrated Stereo Amplifier which possesses a great many separate component class features and characteristics. Full play has been given in its design to the advanced engineering techniques that were developed for the P-300 Power Amplifier and the C-200 Control Center which spearheaded the Accuphase line of highest quality audio equipment. Among the many special features of the E-202 are the following.

- **High power output of 100 watts per channel into 8 ohms assures excellent sound quality at ALL listening levels.**

This high power capability, with distortion at less than 0.1% over the entire audio range of 20 to 20,000 Hz, is fully guaranteed. Heavy duty power transistors in a parallel push-pull drive output stage and large heat sinks back up this Accuphase Warranty. Design emphasis was placed on maintaining excellent sound quality also at the low listening levels.

- **Speaker Damping Control ensures best speaker performance.**

A Speaker Damping Control permits correct matching and best performance from any speaker by changing the damping factor from more than 20 at NORMAL position, (8 ohms load) to 5 at MEDIUM and 1 at SOFT positions. Use the position that you desire.

- **Power Meters help to balance channel levels.**

Momentary intensities of clipping level and left and right channel balance can be checked and corrected easily with the Power Meters on the front panel which indicate output levels in decibels (dB). A Meter Sensitivity Control is also provided to assure sufficient meter deflection for easy reading at low listening levels.

- **Equalizer circuit assures quality sound.**

This circuit can handle inputs up to 300mV rms with distortion less than 0.05% at 1 kHz, and ensures faithful passage of practically any size pulse. It is a direct coupled, 3-stage, constant current load, differential amplifier circuit which has outstanding linearity characteristics. It is supplied by a dual (positive and negative) power supply system which accounts for its very high performance.

- **Exclusive "Accuphase Only" Features — Low Enhancement Circuit and Disc Subsonic Filter.**

This amplifier is also provided with a Low Enhancement switch and Subsonic Filter that were introduced first in the Accuphase C-200 and received very favorable recognition. The Disc Low Enhancement switch permits +1 dB enhancement of the RIAA recording standard characteristics at 100 Hz, and enables delicate application of "presence" to music that is not possible with ordinary tone controls.

The Subsonic Filter eliminates any adverse effect in

the audible range that may be caused by very low frequency turntable and/or tone arm resonance below 25Hz, by barring their entry into the amplifier.

- **Input Level Control is provided for DISC 1.**

An Input Level Control that is variable over a range of 6 dB is provided at DISC 1 which enables attenuation of high output level cartridge. It is also useful to equalize the input levels at DISC 1 and DISC 2, and to judge the sound quality of the two cartridges.

- **Input Impedance Selector switch is provided for DISC 1.**

DISC 1 has provisions for impedance matching to any kind of cartridges. This is achieved with a 3-step Impedance Matching Switch which provides impedance selection of 30-kohm, 47-kohm or over 100-kohm.

- **Tone Control permits 2 dB tone variation.**

The tone control varies the tones of both the left and right channels simultaneously and simplifies operation. It has a range of  $\pm 10$  dB that is divided accurately into steps of 2 dB. Its turnover frequencies of 500 Hz for bass and 2,500 Hz for treble are ideal from an acoustic standpoint in controlling tone smoothly and naturally.

- **Three tape decks can be connected. Tape Copy switch is independent.**

Two tape decks can be operated simultaneously in conjunction with this amplifier which has the necessary circuitry to accommodate them. It also has a front panel input-output jack for connection to a third tape deck, but when this is used, the tape deck connected to one of the rear panel jacks is automatically cut off. An independent tape copying switch also permits tape duplication from one tape deck to another, while listening simultaneously to another program source.

- **Constant regulated voltages from the power supply assure outstanding stability.**

Regardless of the signals handled, a special power supply delivers constantly regulated, non-fluctuating voltages to every stage of this amplifier excepting the output circuit which is supplied separately. This power supply is capable of very stable performance even against AC line voltage fluctuations.

- **Protection Circuit safeguards power transistors and speakers.**

The E-202 has a built-in Protection Circuit which guards against any damage to speakers or power transistors in the case of shorts in the speaker circuit, or when abnormally low impedance output load conditions occur. In case of a short circuit in the speaker network, the speakers are immediately cut off automatically from the amplifier. Likewise they are reconnected automatically as soon as the short circuit condition is corrected.



# INTERCONNECTION OF COMPONENTS

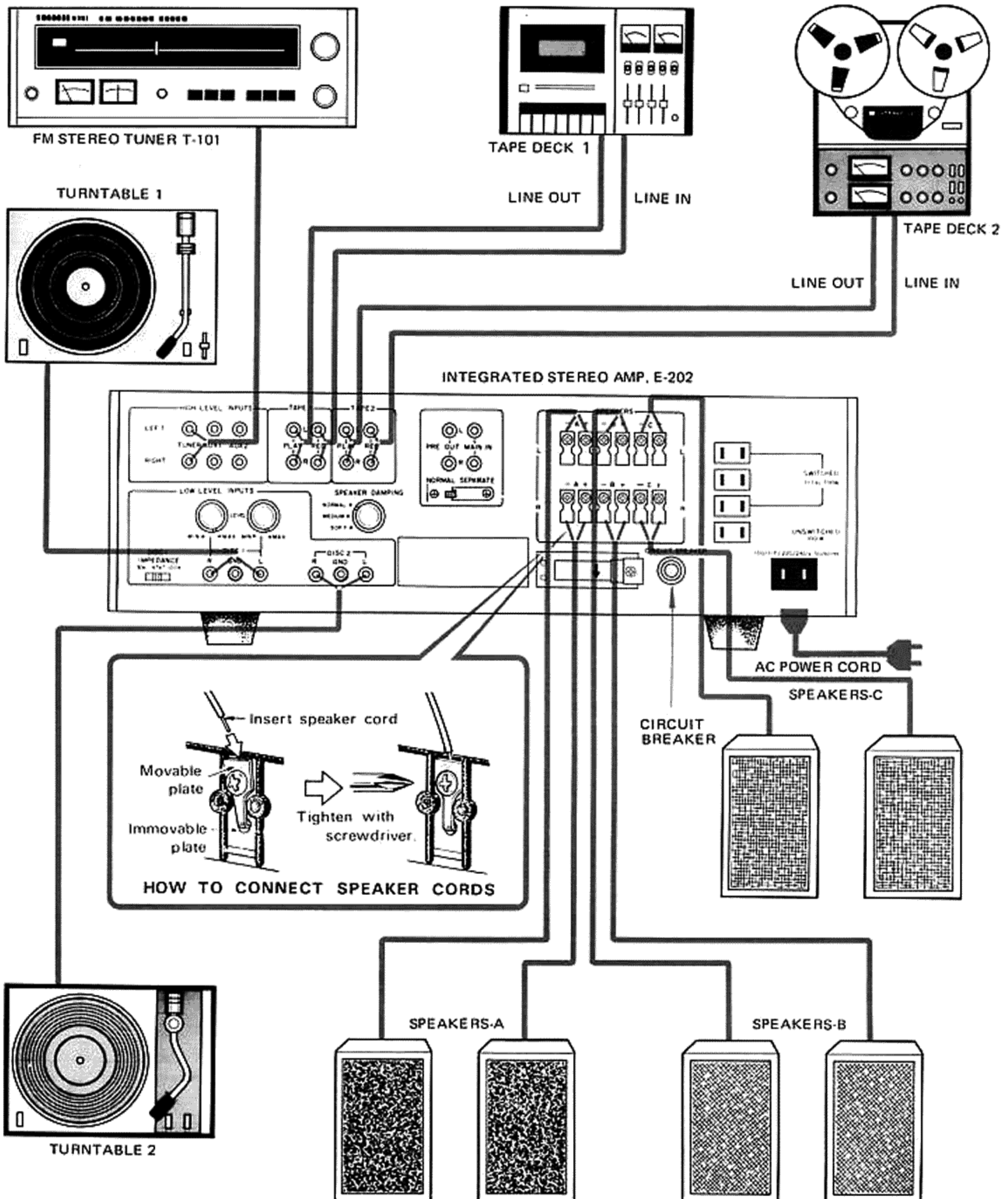

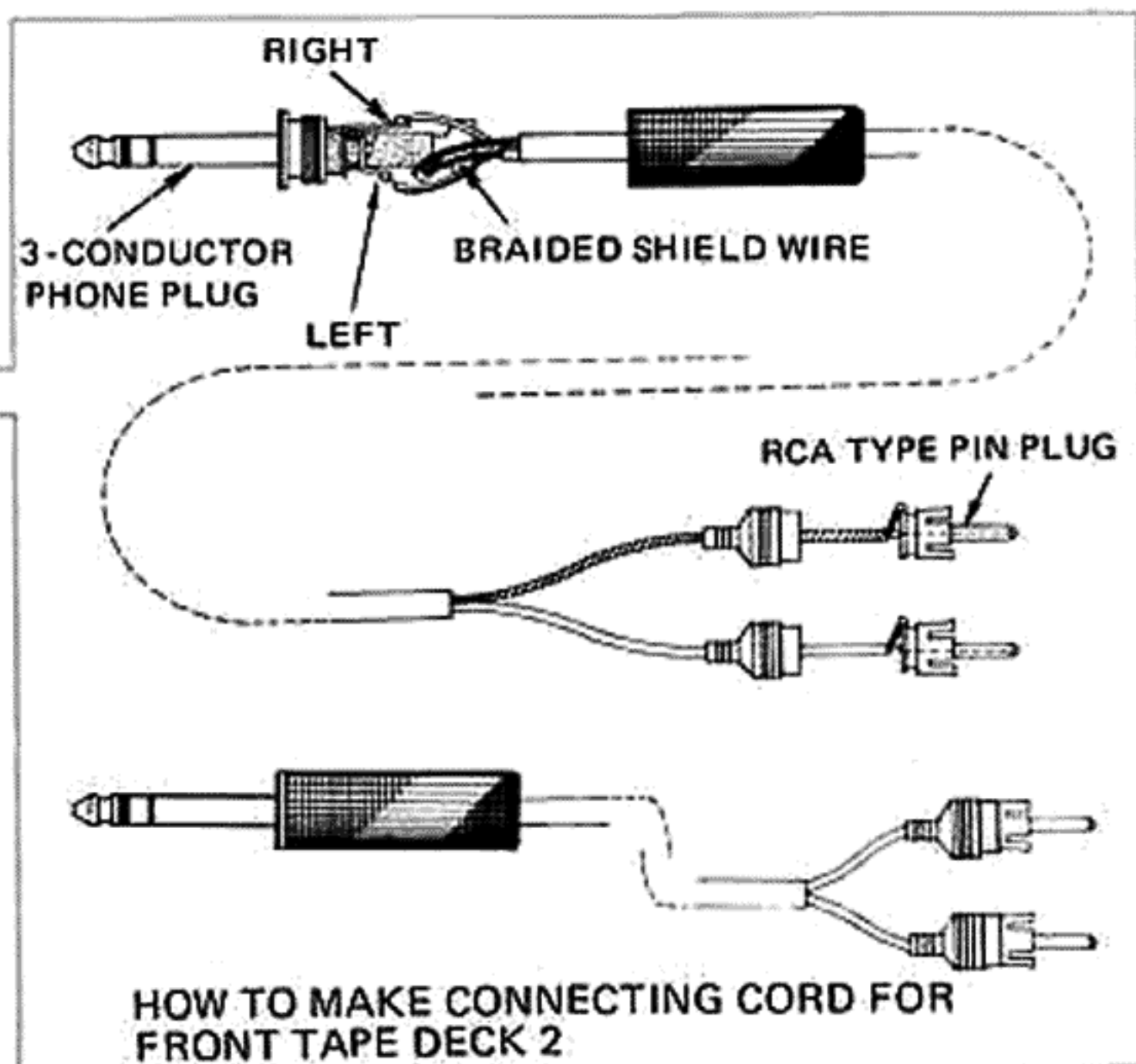
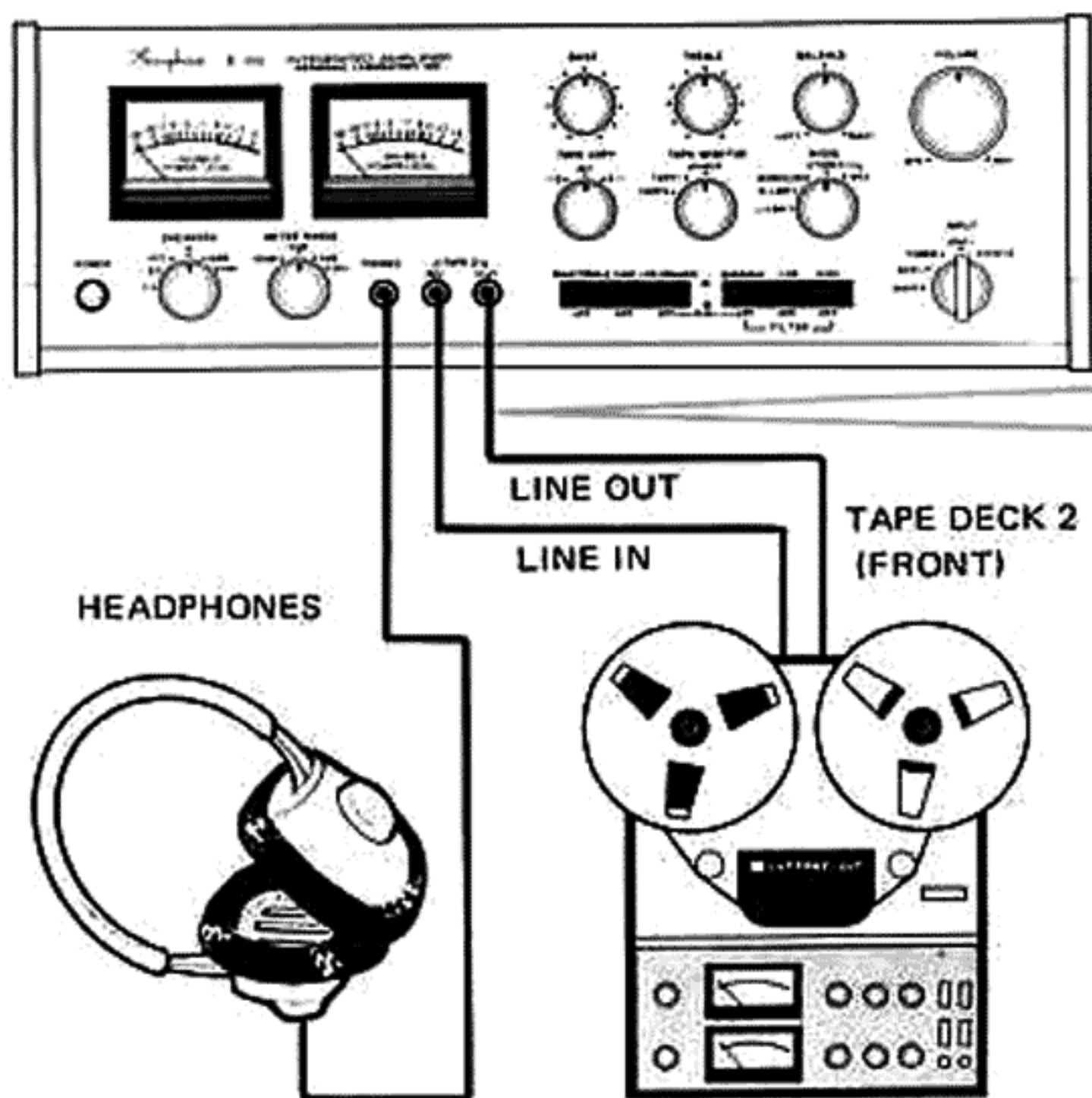

## PRECAUTIONS BEFORE USING

- **USE LOW CAPACITY SHIELDED CORD**

Shielded cord must be used to interconnect the components of a system such as the tuner, amplifier, players, tape decks, etc. It is important to select best quality, low capacity cables for this function. Thin, high capacity shielded cords not only sacrifice high frequency response, but are likely to pick up undesirable noises. Remember also to keep interconnecting shielded cords between components as short as possible.

- **VENTILATION**

Since high power amplifiers create a good amount of heat, air vents are provided on all sides of this unit. It is important to keep space around the amplifier open so that air can circulate freely. Also avoid locations that are exposed to direct sunlight.

- **AMPLIFIER MUST BE RIGIDLY SUPPORTED.**

Since this unit is quite heavy, it should be rigidly supported. Bear this in mind when choosing its location, especially when it is to be placed on a shelf.

- **REDUCE AMPLIFIER VOLUME BEFORE OPERATING RECORD PLAYER**

Always reduce the volume of this unit before operating a record player. This precaution will serve to protect the speakers against possible harm from low frequency, large current surges that may result from lifting or lowering the cartridge, even though sound pressure itself from this action may be minor.

- **TURN POWER SWITCH OFF BEFORE CONNECTING INPUT/OUTPUT**

Be sure to switch AC power OFF before connecting or disconnecting input/output cords. This precaution is necessary also to protect the speakers from possible damage.



# PARTS AND THEIR FUNCTIONS

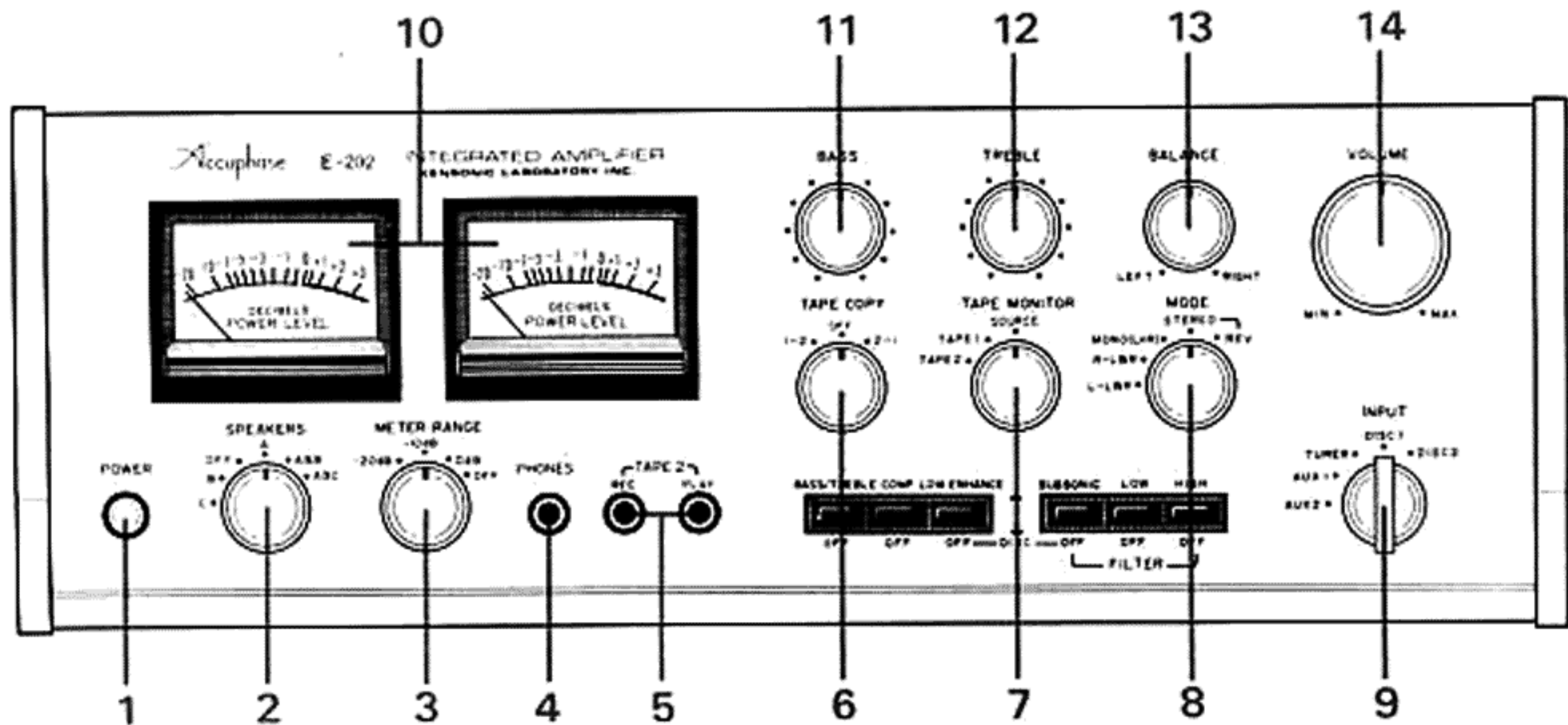

## (1) POWER – Power Switch

Push this button to turn power on. Push it again to turn it off.

## (2) SPEAKERS – Speaker Selector Switch

This switch selects the speaker systems connected to A, B, or C terminals on the rear panel. When it is switched to A&B position, the A and B speakers will be heard simultaneously, if both are connected, and nothing will be heard if only one set of speakers is connected. When this is switched to OFF, all speakers will be silenced and output signal will be available only at the PHONES jack.

## (3) METER RANGE – Meter Range Selector Switch

This switch changes the sensitivity of the power level meters to measure different value ranges. When it is switched to 0 dB, the meter will register 0 dB to indicate a 100 watt output into 8 ohms of a pure sine wave input. Likewise when switched to -10 dB, the meters will register 0 dB to indicate 10 watts, and when switched to -20 dB, meters register 0 dB to indicate 1 watt.

## (4) PHONES – Headphone Jack

Plug stereo headphones into this jack for private listening. Use 4 to 32 ohm headphones here. When a headphone is plugged in, the signal is not cut off at the

SPEAKERS terminals of this amplifier. Therefore, be sure to set the SPEAKERS switch (2) to OFF when listening to headphones only.

## (5) TAPE 2 – Tape Deck Connecting Jacks (front panel)

The TAPE 2 (REC PLAY) jacks on the front panel can be used in exactly the same way as the TAPE 2 (REC PLAY) connectors on the rear panel. Connections to these front panel jacks must be made with stereo plugs while pin plugs must be used for the rear panel connectors.

The diagram below shows a shielded connecting cable for the front panel TAPE 2 jacks. The stereo plug at left connects to the amplifier and the pin plugs at right make the connections to Tape Deck 2.

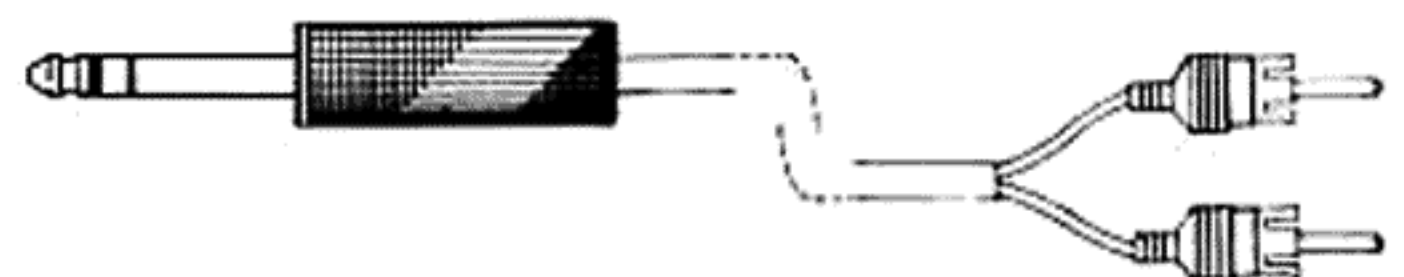

#### **(6) TAPE COPY — Tape Copying Control**

This control is used when copying tape from one tape deck to another. Set this control to 1 → 2 when copying from a tape deck connected to TAPE 1 jack to a tape deck connected to TAPE 2 jacks. Set the control to 2 → 1 when the reverse is the case. Copying can be done independently while listening simultaneously to another program source when the TAPE MONITOR control (7) is set to "SOURCE".

When copying from TAPE 1 to TAPE 2 with the TAPE MONITOR control 7 set to TAPE 1, the playing condition of tape 1 can be checked, and with the TAPE MONITOR control set to TAPE 2, the copied tape can be monitored. Monitoring can also be accomplished in the same manner when copying from TAPE 2 to TAPE 1.

#### **(7) TAPE MONITOR — Tape Monitor Control**

When this control is set to SOURCE, all source signals applied to the INPUT jacks, other than TAPE PLAY jacks, can be reproduced. For this reason, always set this control to "SOURCE" except for tape playbacks.

For tape playbacks, set this switch to TAPE 1 or TAPE 2, whichever jack the tape deck concerned is connected to.

For tape recordings, this switch should be set to SOURCE. This permits monitoring the program source that is being recorded. To check back on the quality of the recording that is being made, merely turn this switch to TAPE 1 or TAPE 2, whichever connected to the tape deck.

#### **(8) MODE — Mode Selector**

When this control is set to L-L&R, left channel sound is heard from both speakers; when it is set to R-L&R, right channel sound is heard from both speakers.

When this control is set to STEREO, left and right channel sounds are completely separated and heard from the respective speakers, providing stereophonic play.

When this control is set to REV, left and right channel sounds are reversed; that is, they will be heard from the opposite side speakers in stereophonic mode.

#### **(9) INPUT — Input Selector**

This switch selects program sources connected to the various INPUT jacks.

#### **(10) POWER LEVEL METERS**

The left side meter indicates left channel and right side meter indicates right channel power output with level indications in decibels (dB). Actual program sources contain momentary pulse intensities not registered by these meters, peak value of which would be 5 to 10 dB above the meter readings.

#### **(11) BASS — Low Frequency Tone Control**

This control functions only when the BASS/TREBLE button (15) is set to "ON". Bass is emphasized as the control is turned to the right of center, and attenuated as the control is turned to the left. Bass emphasis is adjusted in 2 dB steps. Maximum change of  $\pm 10$  dB is obtained at 100 Hz.

#### **(12) TREBLE — High Frequency Tone Control**

This control functions only when the BASS/TREBLE button (15) is set to "ON". TREBLE is emphasized as the control is turned to the right of center, and attenuated as the control is turned to the left. Tone is varied in 2 dB steps. Maximum change of  $\pm 10$  dB is obtained at 10 kHz.

#### **(13) BALANCE — Stereo Balance Control**

When this control is turned clockwise, the sound level of the left speaker is reduced. The sound level of the right speaker is reduced when the control is turned counter-clockwise.

#### **(14) VOLUME — Volume Control**

Sound level increases when this control is turned clockwise.



# PARTS AND THEIR FUNCTIONS

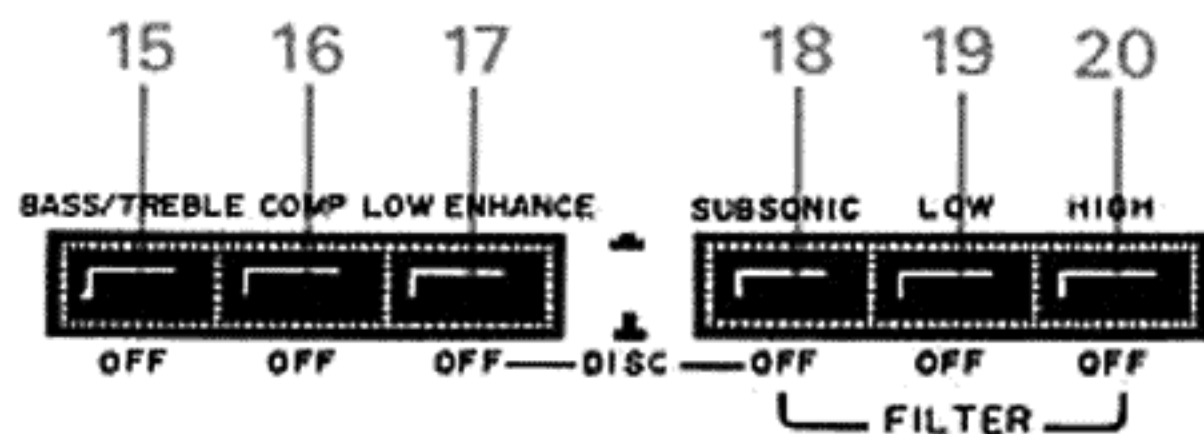

## (15) BASS/TREBLE – Tone Control ON-OFF Switch

When this switch is pushed into locked position, the tone control circuit is activated, allowing the BASS and TREBLE controls to function. When it is pushed again and released, the tone control circuit is turned off, providing a flat frequency response characteristic regardless of the BASS and TREBLE knob positions.

## (16) COMP – Compensator Switch

At low volume levels, the human ear fails to detect low frequency sounds sufficiently. To compensate for this natural deficiency, this switch activates a compensating circuit which boosts bass level at the lower volume levels.

This compensator is interlocked with the volume control and provides up to 9 dB bass boost at 50 Hz when the volume knob is adjusted to the 10 o'clock position.

The compensator is automatically deactivated when the volume knob is set to the 12 o'clock or higher positions, after which a flat frequency response characteristic is obtained even though this switch may remain locked in.

## (17) DISC LOW ENHANCE – Low Frequency Enhancement Switch

This switch is used to enhance low frequency sounds by slightly changing the characteristics of the equalizer. Enhancement of 1 dB against the RIAA curve at 100 Hz is obtained. When this switch is set to OFF, a true RIAA standard response is obtained.

## (18) SUBSONIC – Subsonic Filter

This is used for DISC operation only. When this switch is pushed and locked in, (set to SUBSONIC), subsonic turntable vibrations (25 Hz or lower) are filtered out completely.

## (19) LOW FILTER Switch

When this switch is locked in (set to LOW), it activates the low frequency filter designed to eliminate turntable rumble, etc. This filter provides a 18 dB/oct cut off below 30 Hz.

## (20) HIGH FILTER Switch

When this switch is locked in (set to HIGH), it activates

the high frequency filter which effectively cuts out high frequency noises such as record scratches and FM interference of 5 kHz or higher at 12 dB/oct.

## (21) HIGH LEVEL INPUTS Jacks

These are high level input jacks to accommodate tuners or other auxiliary components.

## (22) DISC 1 IMPEDANCE – DISC 1 Input Impedance Matching Switch

This switch permits quick impedance matching of turntable cartridges connected to the DISC 1 jacks.

It should be set to 47 kohms for general type cartridges, or to the impedance that is closest to the rating of the coupling transformer.

## (23) DISC 1 LEVEL Control

If the output level of the turntable connected to DISC 1 jacks is excessive, it can be reduced with this control. Normally this control should be set to MAX position.

## (24) LOW LEVEL INPUT-DISC 1

These are input jacks for turntable connections. DISC 1 input jacks are provided with input level and impedance matching controls on the rear panel.

## (25) LOW LEVEL INPUT-DISC 2

These are input jacks for a second turntable. DISC 2 input jacks have no input level control nor impedance matching control. Their input levels are the same as MAX position of DISC 1, and input impedance is 47 kohms.

## (26) TAPE 1 – Tape Deck Connecting Jacks

The PLAY jacks are for the LINE OUT jacks of a tape deck, and REC jacks for the LINE IN jack of a tape deck.

## (27) TAPE 2 – Tape Deck Connecting Jacks (rear panel)

A tape deck can be connected to these jacks in the same way as explained above in (26). The connections here are automatically cut off when stereo plugs are inserted in the front panel TAPE 2 connecting jacks.



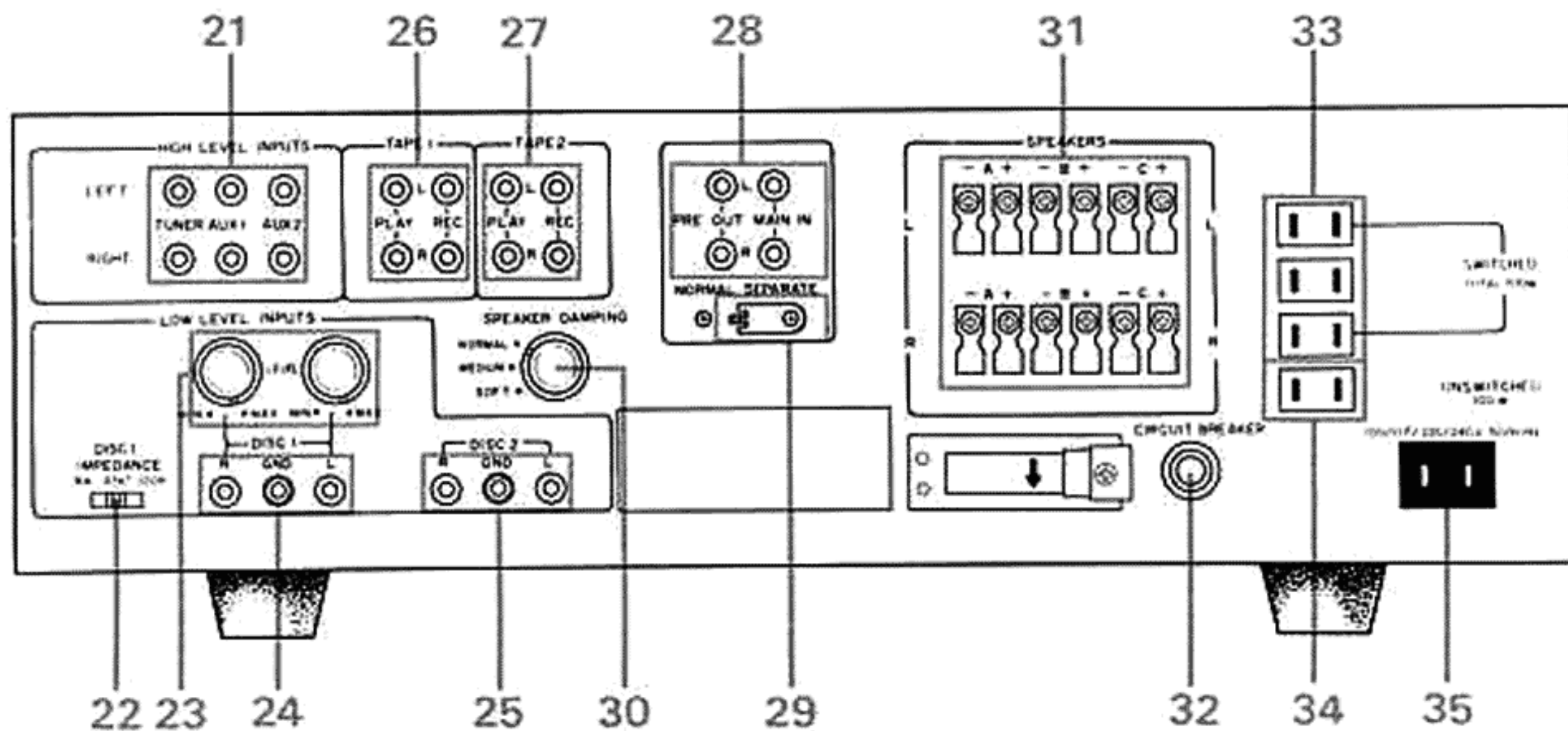

**(28) PRE OUT – MAIN IN – Preamplifier Output and Main Amplifier Input Connectors.**

The preamplifier and the main amplifier sections become separated when Switch (29) is set to SEPARATE. The preamplifier output is then available at PRE-OUT and MAIN IN becomes the input connectors for the main amplifier.

**(29) PRE-MAIN – SEPARATE Switch**

This switch can be used to separate the preamplifier and main amplifier sections if and when such separate functions are desired. Otherwise, it should always be set to NORMAL.

**(30) SPEAKER DAMPING – Speaker Damping Control**

This control is ordinarily used at NORMAL position. Switching it to MEDIUM or SOFT position, however, changes the speaker damping factor respectively to 5 and 1, and causes a softer sound quality. Learn to make use of this control and enjoy the sound variation that it offers.

They will make audiophiles appreciate their "old favorite" speakers even more because of the different soothing sound that they will be able to get from them.

**(31) SPEAKERS – Speaker Terminals**

Use 4 to 16 ohms speakers for connection to these terminals. The speaker systems connected to these three sets of terminals are selected by the front panel SPEAKERS switch (2).

**(32) CIRCUIT BREAKER**

This serves the same function as a fuse. It breaks the circuit automatically and prevents possible damage when an excessive current flow occurs. The button (33) pops out about 5 mm when this switch goes into action and breaks the circuit.

AC power will flow again when the button is pushed in after the cause of the trouble is removed.

**(33) SWITCHED TOTAL 300 W – Switched AC Convenience Outlets**

When the power switch of this amplifier is turned ON or OFF, all components connected to these receptacles are turned ON or OFF simultaneously. Total power consumption of the components connected should not exceed watts.

**(34) UNSWITCHED – AC Receptacle**

When the power cord of this amplifier is connected to an AC power supply, the same line voltage is delivered to this receptacle regardless of the position (ON or OFF) of the power switch. This AC outlet may be used to power other associated components.

**(35) AC POWER CORD RECEPTACLE**

Connect the AC power cord that is supplied with this unit to this receptacle.

# OPERATING INSTRUCTIONS

## • TURNTABLE

After connecting the output cords of the turntable to DISC 1 or DISC 2 jacks, and having confirmed that Left and Right channel sides have been connected correctly to the L and R jacks respectively, operate the turntable and the amplifier as follows:

- (1) When the turntable is connected to the DISC 1 jacks, set the rear panel DISC 1 IMPEDANCE switch (22) to the impedance of the cartridge used. This will be the 47 K ohms setting for general type cartridges. For moving-coil type cartridges which use a coupling transformer, set this switch closest to the impedance rating of the coupling transformer.
- (2) Set the rear panel DISC 1 LEVEL CONTROL (23) to MAX position.
- (3) Set the INPUT selector (9) to DISC 1 or DISC 2, whichever is connected.
- (4) Set the MODE selector (8) to STEREO.
- (5) Set the TAPE MONITOR control (7) to SOURCE.
- (6) Increase volume gradually.
- (7) If the cartridge output level is excessive, attenuate with DISC 1 LEVEL control (28) on the rear panel.
- (8) Use BALANCE control (13) to balance the levels of the left and right channels while listening to the speaker sound. Under normal conditions, this BALANCE control is set at the center.
- (9) Adjust tone controls to match room acoustics, program source and your personal preference. Under normal conditions, tone controls are set near their midpoint positions.
- (10) Activate the SUBSONIC Filter by pushing in and locking the SUBSONIC switch (18) which will eliminate subsonic turntable vibrations. It is recommended to keep this switch always locked in to protect the speaker from possible harm from large current surges of a subsonic nature.
- (11) When a turntable is connected to DISC, it is possible to enhance the low frequency bass with the front panel DISC LOW ENHANCE switch (17) by changing the characteristic of the equalizer circuit.

## • TUNER

Make sure that the left and right channel output cords of the tuner, are correctly connected to the L and R TUNER jacks of this amplifier. Set the INPUT selector to "TUNER". Operation is basically the same thereafter, as just explained for playing disc records.

SUBSONIC FILTER and LOW ENHANCE switches are disconnected.

## • TAPE DECK CONNECTIONS AND OPERATION

Make sure that the tape deck is connected correctly to the amplifier. Amp side REC jacks should be connected to the LINE IN terminals of the tape deck. Likewise the PLAY jacks should be connected to the LINE OUT terminals of the tape deck. Refer to the tape deck Owner's Manual for operation of the tape deck.

### Tape Playback

Use the TAPE MONITOR switch to select the desired tape deck. This switch permits selection of one of two tape deck systems that can be connected to TAPE 1, TAPE 2 (rear or front panel).

### Recording

Follow the steps below for tape recording.

- (1) Select the program source desired and listen to the sound from the speakers.
- (2) Switch the tape deck to the recording mode, and the sound from the speakers will then be recorded.
- (3) The VOLUME, TREBLE and BASS controls of this amplifier do not affect the recording signal. The recording level is controlled at the tape deck side.
- (4) While recording, the just recorded tape can be monitored by switching the TAPE MONITOR Switch to whichever terminal the tape deck is connected.
- (5) Two tape decks can be connected and recordings made on them simultaneously if desired.

### How to copy tapes

This amplifier is equipped with a TAPE COPY switch which permits copying a tape from one tape deck to another while simultaneously listening to a different program source, ie., a radio program or DISC entertainment. To copy tape from one tape deck to another, follow the steps below:

- (1) Connect tapedecks to the TAPE 1 and TAPE 2 jacks.
- (2) When the tape deck connected to TAPE 1 is the master and TAPE 2 is the recording deck, set the TAPE COPY control to 1 → 2. In the reverse case, set this control to 2 → 1.
- (3) Set master and recording decks respectively to playback and recording modes. Signals from the master deck are copied into the tape on the copying deck.



- (4) When TAPE COPY is set to 1 → 2, and TAPE MONITOR is set to "TAPE 1", the master deck can be monitored. Likewise when TAPE MONITOR is set to "TAPE 2", the copied tape can be monitored. (When TAPE COPY is set to 2 → 1, the above is reversed).
- (5) Set TAPE MONITOR to "SOURCE". You can then listen to a different program through the tuner or a turntable while tape is being copied from one tape-deck to another.

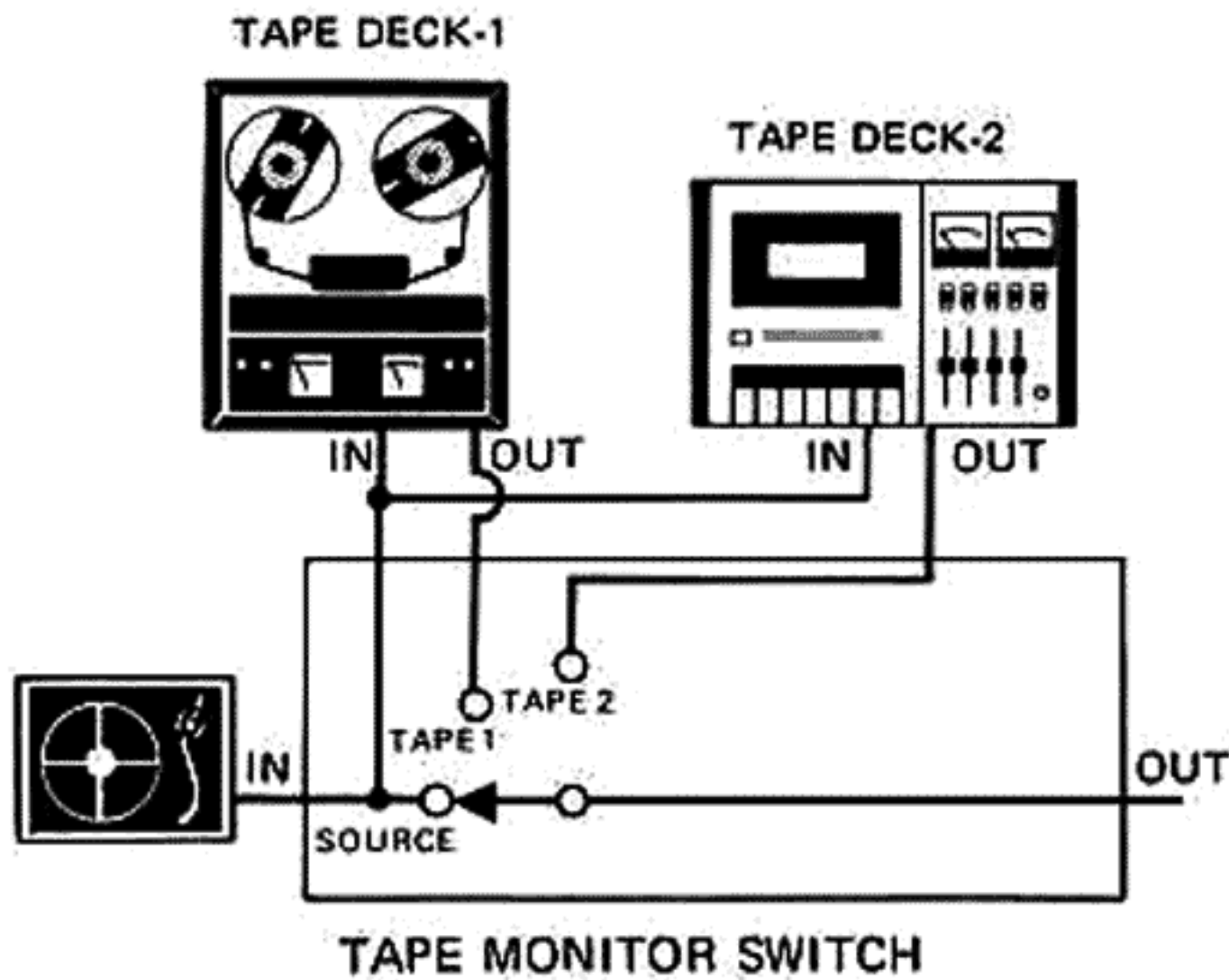

#### ● HOW TO USE THE POWER LEVEL METERS AND METER RANGE SWITCH

When the METER RANGE switch is set to "0 dB", the power level meter will register 0 dB when the power output is 100 watts.

When it is set to "-10 dB" the meter will register "0 dB", to indicate a power output of 10 watts, and when set to "-20 dB", the meter will register 0 dB to indicate a power output of 1 watts.

It is always best to set the METER RANGE switch to 0 dB position first to protect the meter pointer from over-swinging. The switching should then be advanced to -10 dB or -20 dB position if meter deflection proves insufficient for efficient reading.

The above power level indications apply to 8 ohm loads. For 4 ohm loads the same meter reading indicates twice the above-mentioned power, and for 16 ohm loads one half the power.

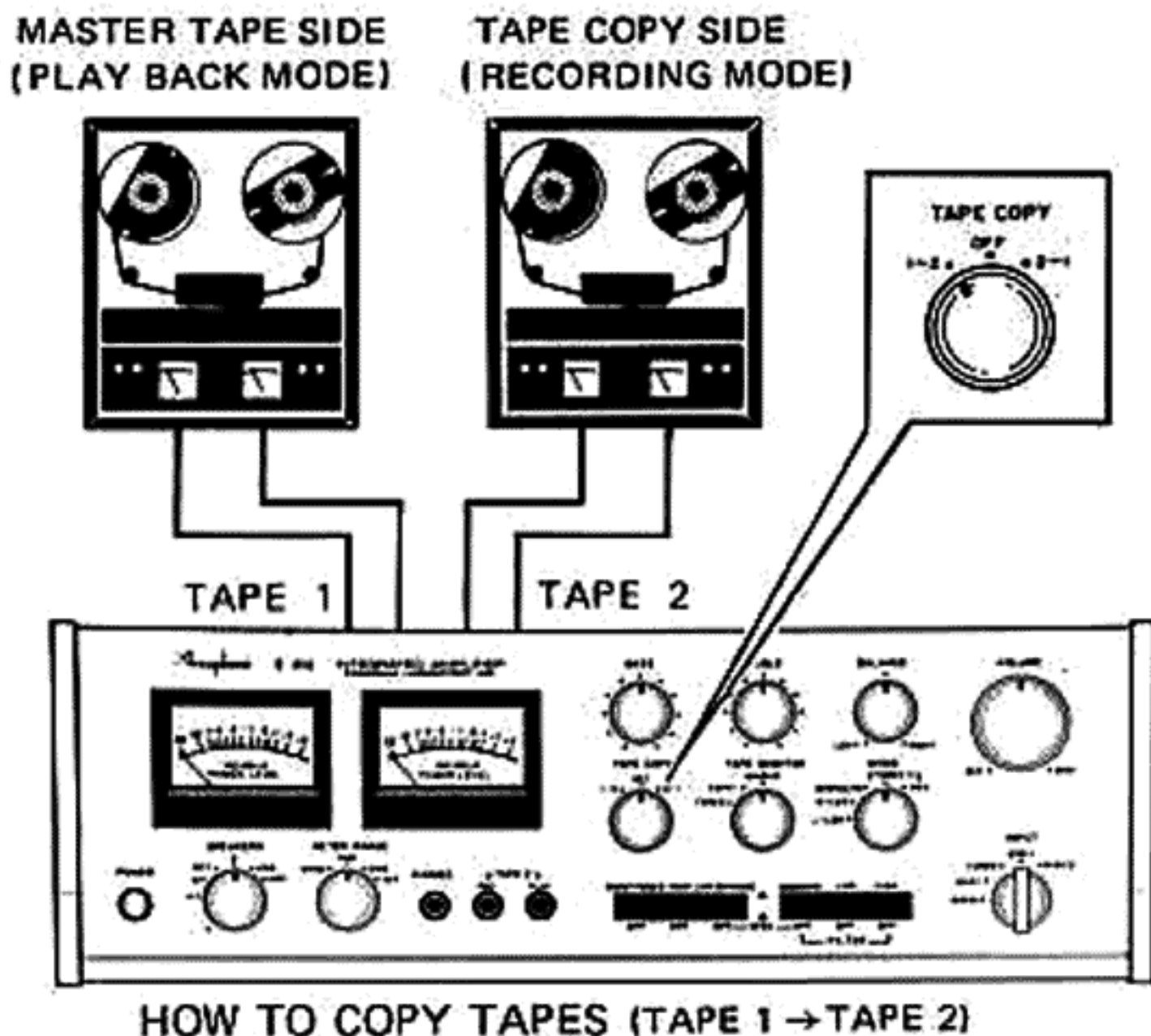

HOW TO COPY TAPES (TAPE 1 → TAPE 2)

# MAINTENANCE

## • What to do when the Circuit Breakers Cuts off AC Power.

Push the Circuit Breaker button in as shown in the following side view diagram (top) if it should pop out as shown below and cut off the AC power. If the button should pop out again, it is an indication of some trouble that requires further investigation. In such a case, contact your Accuphase dealer.

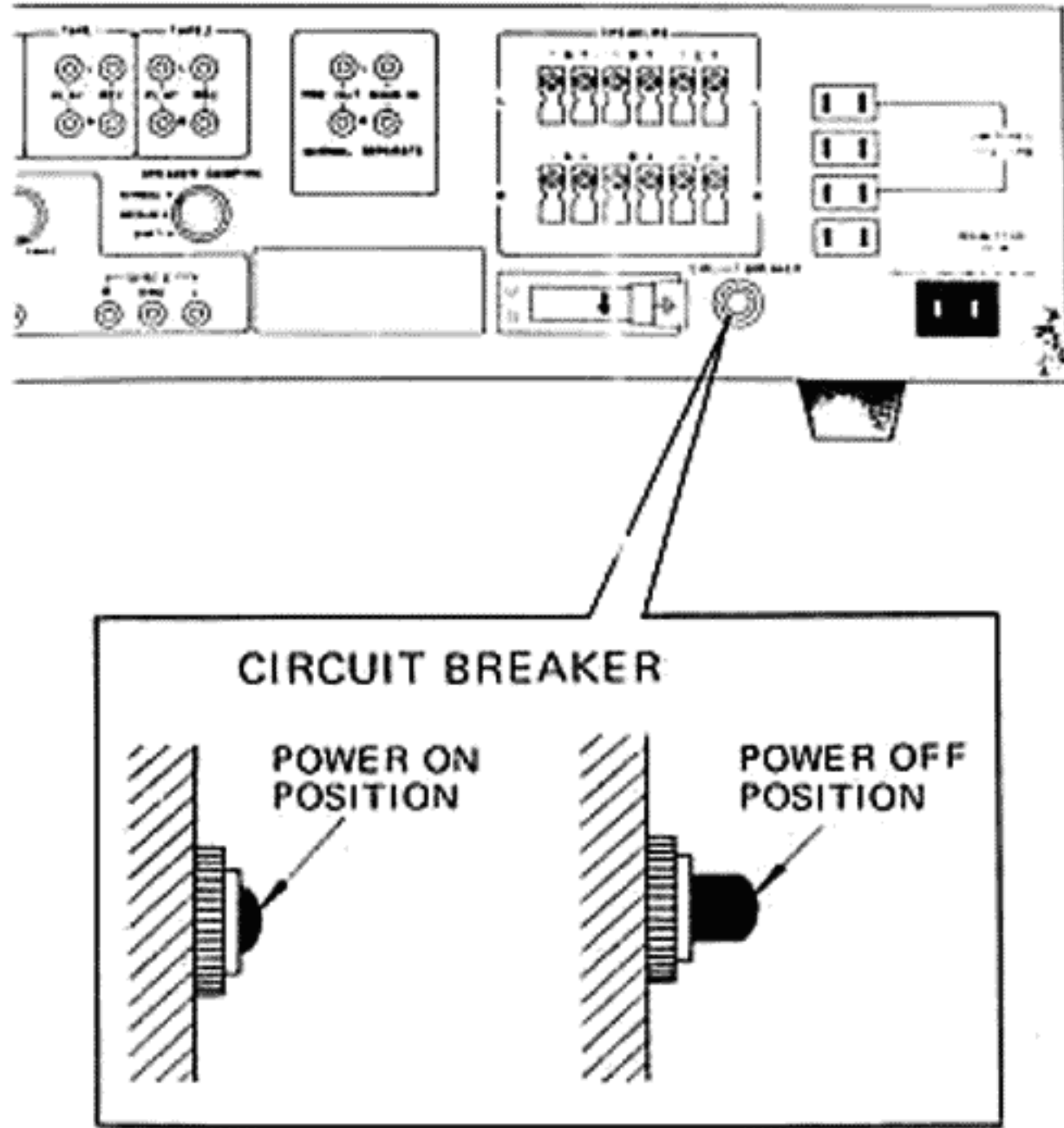

## • Operation of the Protection Circuit

In order to prevent damage to power transistors and speaker systems, this unit has three protection circuits, a Speaker Relay Switch which normally connects the power amplifier to the speakers, and a Relay Control Amplifier. The action of this Relay Control circuit between the time AC power is turned on until it triggers the relay to connect the speakers is described briefly below. (Also refer to block diagram).

When AC power is OFF, the Speaker Relay contacts are at points "B" as shown, and the speakers are not connected. "B" connects to one side of the power transformer secondary winding through R1.

When AC power is turned ON, an alternating current (50Hz or 60 Hz) voltage is created in the power transformer secondary, and current flows through R1 and points "B" to the speakers. If the speaker return circuits are connected properly to a common ground, this circuit impedance combines with the resistance of R2 to create a voltage at

point "A" that causes the Relay Control Amplifier to trigger the Speaker Relay. Contact points then switch to "M" and the Relay connects the power amplifier outputs to the speakers. The Relay Control Amplifier circuit is designed to provide about a four second delayed action — the time required for proper circuit warmup — before triggering this power amplifier-speaker connection. Consequently, a tiny AC voltage of about 10 to 20 mV flows through the speakers and it may appear during this very short interval as a slight hum through high efficiency speakers.

In case of a short circuit in the speaker network, or defect within the speakers themselves that may cause impedance to drop below low ohms, the resulting low voltage at point "A" will be insufficient to activate the Relay Control Amplifier. As a result, the power amplifier outputs will be prevented from driving the speakers as the Speaker Relay contacts will remain at points "B". In such a case no click will be heard from the Speaker Relay even after more than 4 seconds elapse from the time AC power is turned on.

If this should happen, disconnect the speaker circuit, or switch the Speaker Selector to an open position to which no speakers are connected. If a click is then heard shortly after AC power is turned on, it indicates that something is definitely wrong in the speaker circuit and miswiring, or whatever it is, must be corrected.

As explained above, it is normal for a slight hum to be heard before a click is heard during the short period after AC power is turned ON. It indicates that the speakers are wired correctly and is not a cause for concern.

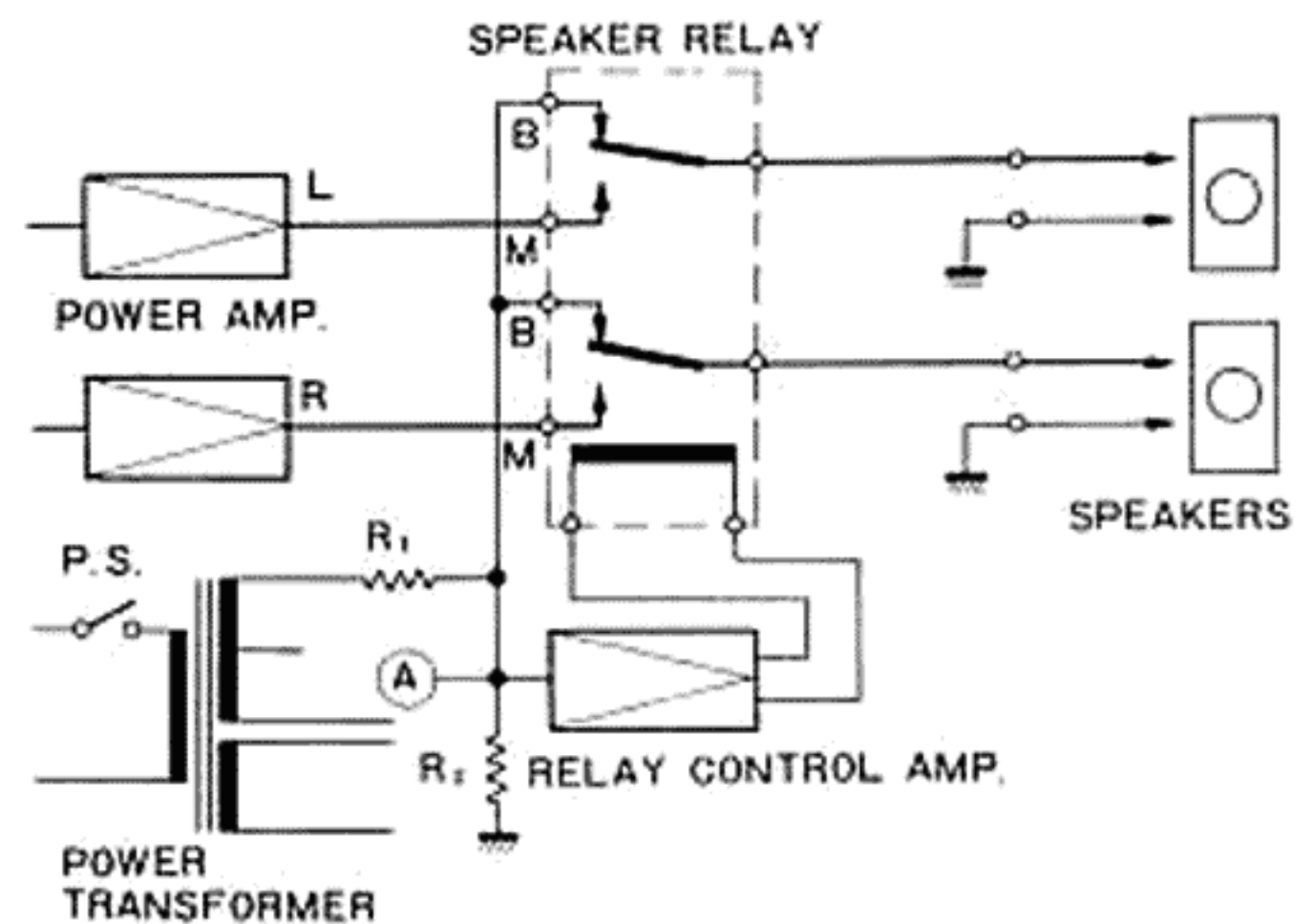



# BLOCK DIAGRAM

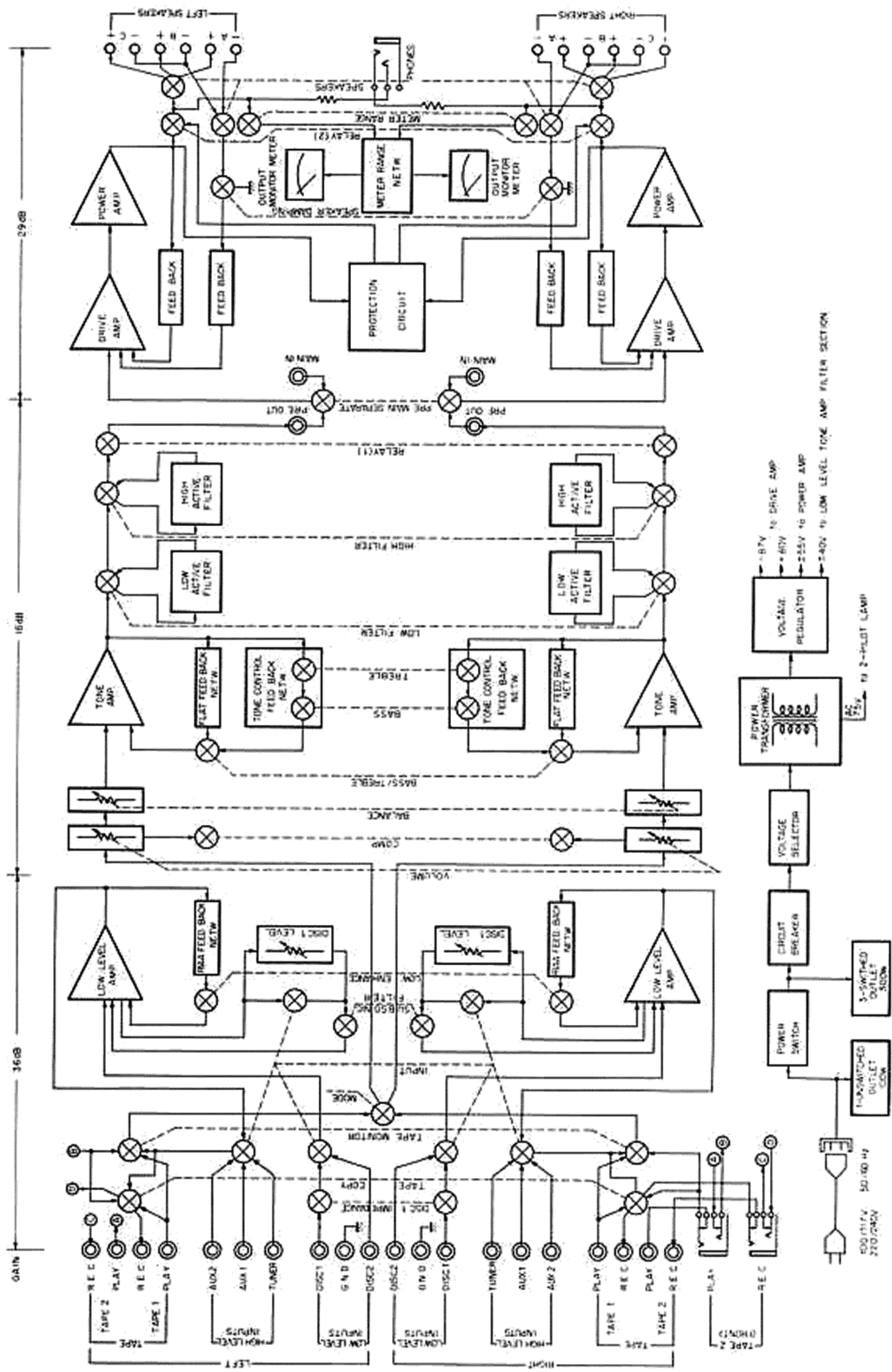

# GUARANTY SPECIFICATIONS

<b>PERFORMANCE GUARANTY:</b>	Products of Accuphase guarantee specifications stated.
<b>POWER OUTPUT:</b>	140 RMS watts continuous per channel into 4ohms 100 RMS watts continuous per channel into 8ohms 50 RMS watts continuous per channel into 16ohms (with both channels operating simultaneously at any frequency from 20Hz to 20,000Hz)
<b>HARMONIC DISTORTION:</b>	(High Level Input to Main Output) will not exceed 0.1% at rated power output will not exceed 0.05% at half of rated power output (at any frequency from 20Hz to 20,000Hz)
<b>INTERMODULATION DISTORTION:</b>	(High Level Input to Main Output) will not exceed 0.1% at rated power output for any combination of frequencies between 20Hz and 20,000Hz
<b>FREQUENCY RESPONSE:</b>	Main Amp. Input ; +0, -0.2dB High Level Input ; +0, -0.5dB Low Level Input ; +0, -1.0dB (at rated power output from 20Hz to 20,000Hz)
<b>DAMPING FACTOR:</b>	(at 8ohms load, 20Hz to 20,000Hz) set "SPEAKER DAMPING" switch to: "NORMAL" "MEDIUM" "SOFT" over 20 5 1
<b>INPUT SENSITIVITY AND IMPEDANCE:</b>	Disc 1 : 2.5-5mV* ; 30kohms, 47kohms, 100kohms Disc 2 : 2.5mV ; 47kohms High Level Input : 160mV ; 100kohms Main Amp. Input : 1.0V ; 100kohms (*2.5-5mV variable)
<b>MAXIMUM INPUT FOR LOW LEVEL INPUT:</b>	Disc 1 ; 300mV RMS at disc level control maximum for 1kHz 600mV RMS at disc level control minimum for 1kHz Disc 2 ; 300mV RMS (distortion 0.05% at 1kHz).
<b>OUTPUT LEVEL AND IMPEDANCE:</b>	Preamp. Output ; 1.0V , 600ohms (at Rated Input Level) Tape Rec. 1, 2 ; 160mV , 200ohms
<b>HEADPHONE JACK:</b>	For listening with low impedance (4-32ohms) dynamic stereo headphones
<b>VOLTAGE AMPLIFICATION IN DECIBELS:</b>	Main Amp. Input to Output ; 29dB High Level Input to Preamp. Output ; 16dB (at VOLUME control maximum) Low Level Input to Tape Rec. ; 36dB (Disc 1 level control has 6dB variation)
<b>HUM AND NOISE:</b>	Main Amp. Input ; 94dB below rated output High Level Input ; 80dB below rated output Low Level Input ; 74dB below rated output when adjusted for 10mV input at 1kHz
<b>BASS/TREBLE controls:</b>	10-step Rotary Switch for both channels with ON-OFF switch. Tone is varied in 2 dB steps. BASS turnover frequency ; 400Hz, ±10dB at 100Hz TREBLE turnover frequency ; 2.5kHz, ±10dB at 10,000Hz
<b>VOLUME control:</b>	Less than 1dB tracking error.
<b>COMPENSATOR:</b>	ON position boosts low frequencies for low level listening. +9dB boost at 50Hz when the volume knob is adjusted to -30dB position.
<b>DISC LOW ENHANCEMENT:</b>	(for Disc Input) +1dB at 100Hz to RIAA standard characteristics when set "LOW ENHANCE" switch to ON position.
<b>FILTERS:</b>	Disc Subsonic Filter ; 25Hz cutoff 6dB/oct Low Filter ; 30Hz cutoff 18dB/oct High Filter ; 5kHz cutoff 12dB/oct
<b>POWER LEVEL METER:</b>	Meter is calibrated to read 0dB when amplifier produces 100 watts into 8ohms load. METER RANGE switch is provided to increase meter sensitivity by 10dB or 20dB.
<b>OUTPUT LOAD IMPEDANCE:</b>	4, 8 and 16ohms
<b>POWER CONSUMPTION:</b>	70 watts at zero signal output 375 watts at rated power output into 8ohms load
<b>SEMICONDUCTOR COMPLEMENT:</b>	53 Transistors, 4 FET's, 44 diodes, 2 Thermistors
<b>DIMENSIONS:</b>	455mm (18 inches) wide, 152mm (6 inches) high, 355mm (14 inches) deep
<b>WEIGHT:</b>	19.5kg. (42.9Lbs.) net, 23.8kg. (52.3Lbs.) in shipping carton.



# PERFORMANCE CURVES

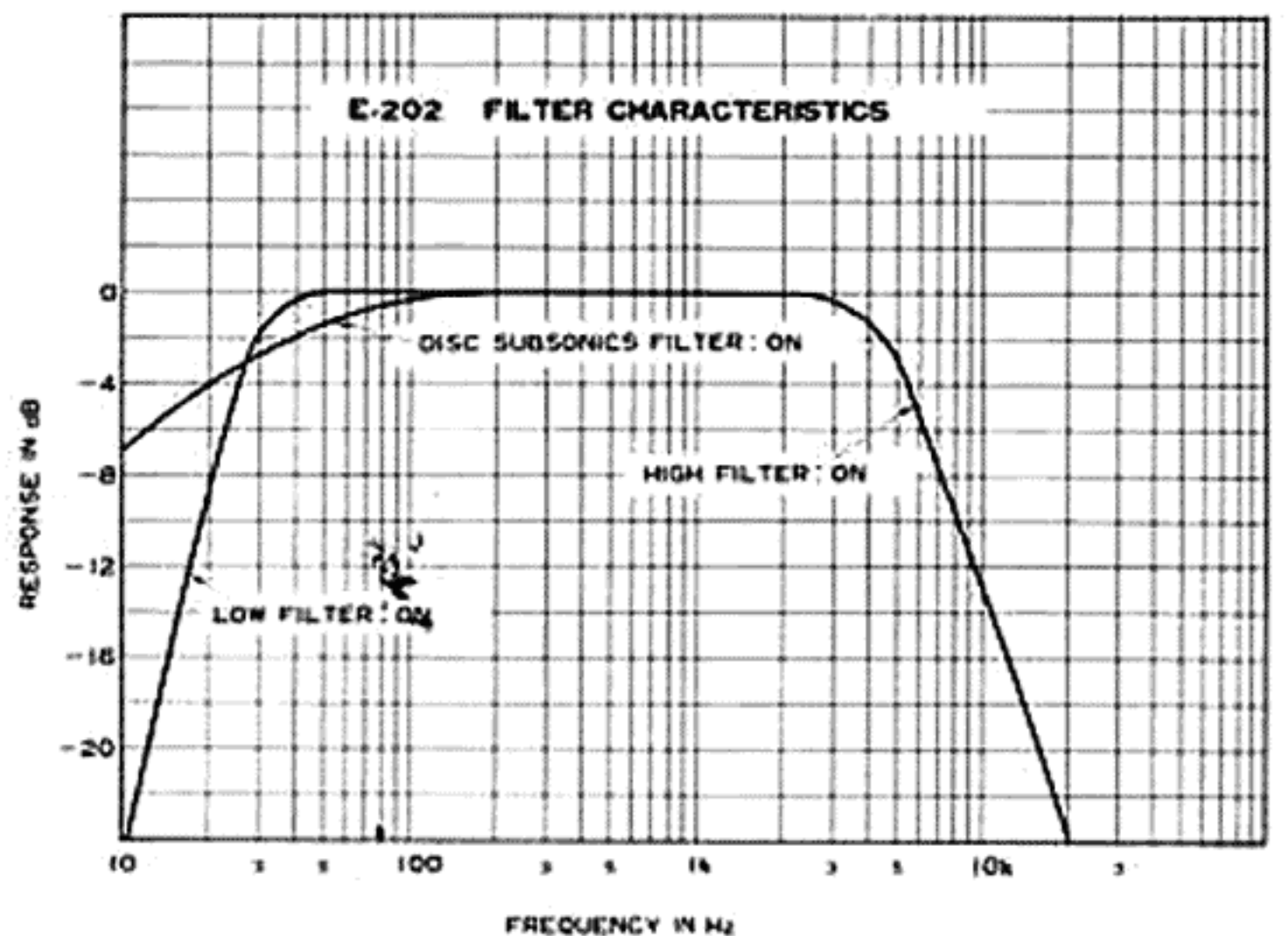
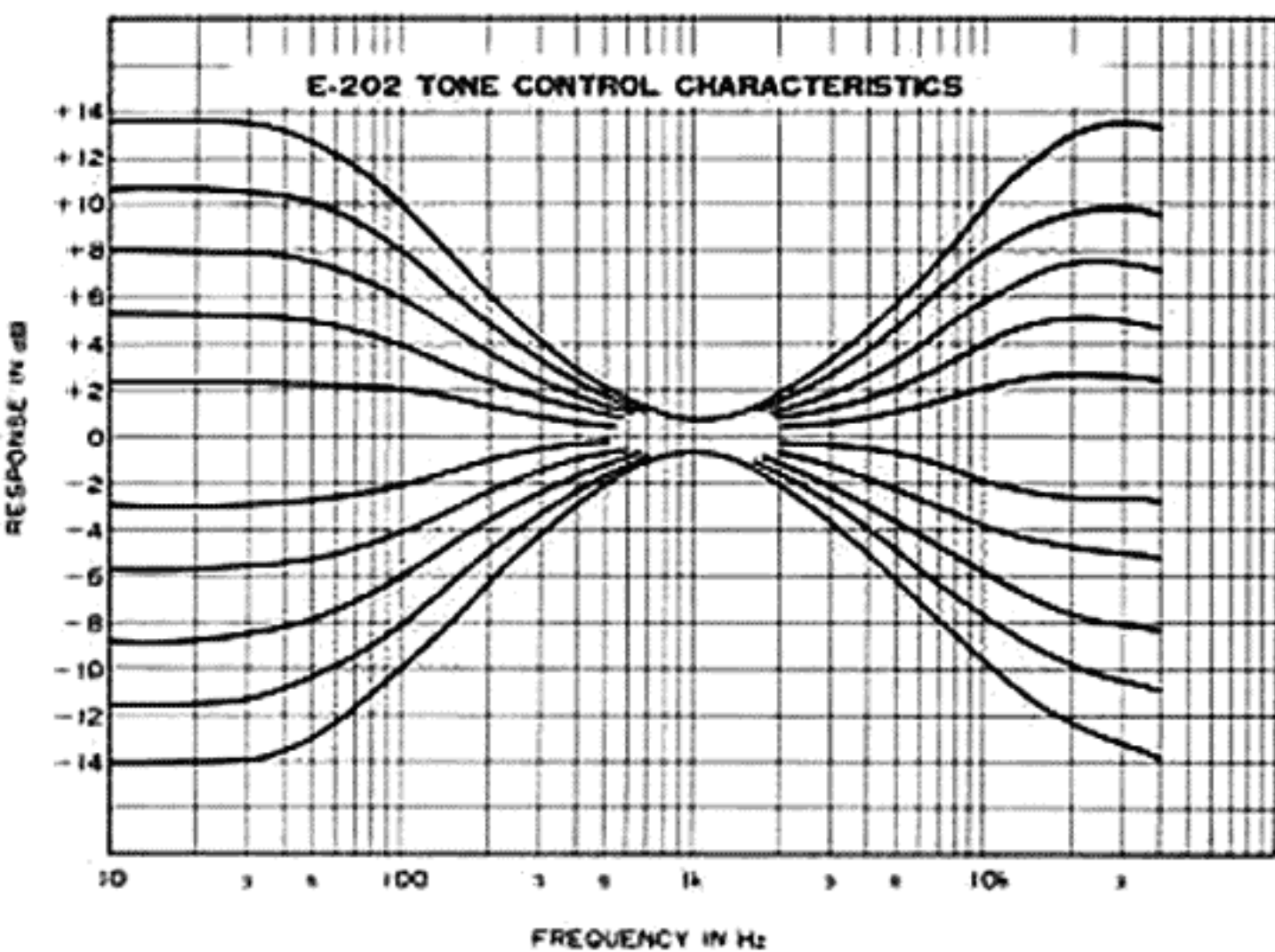
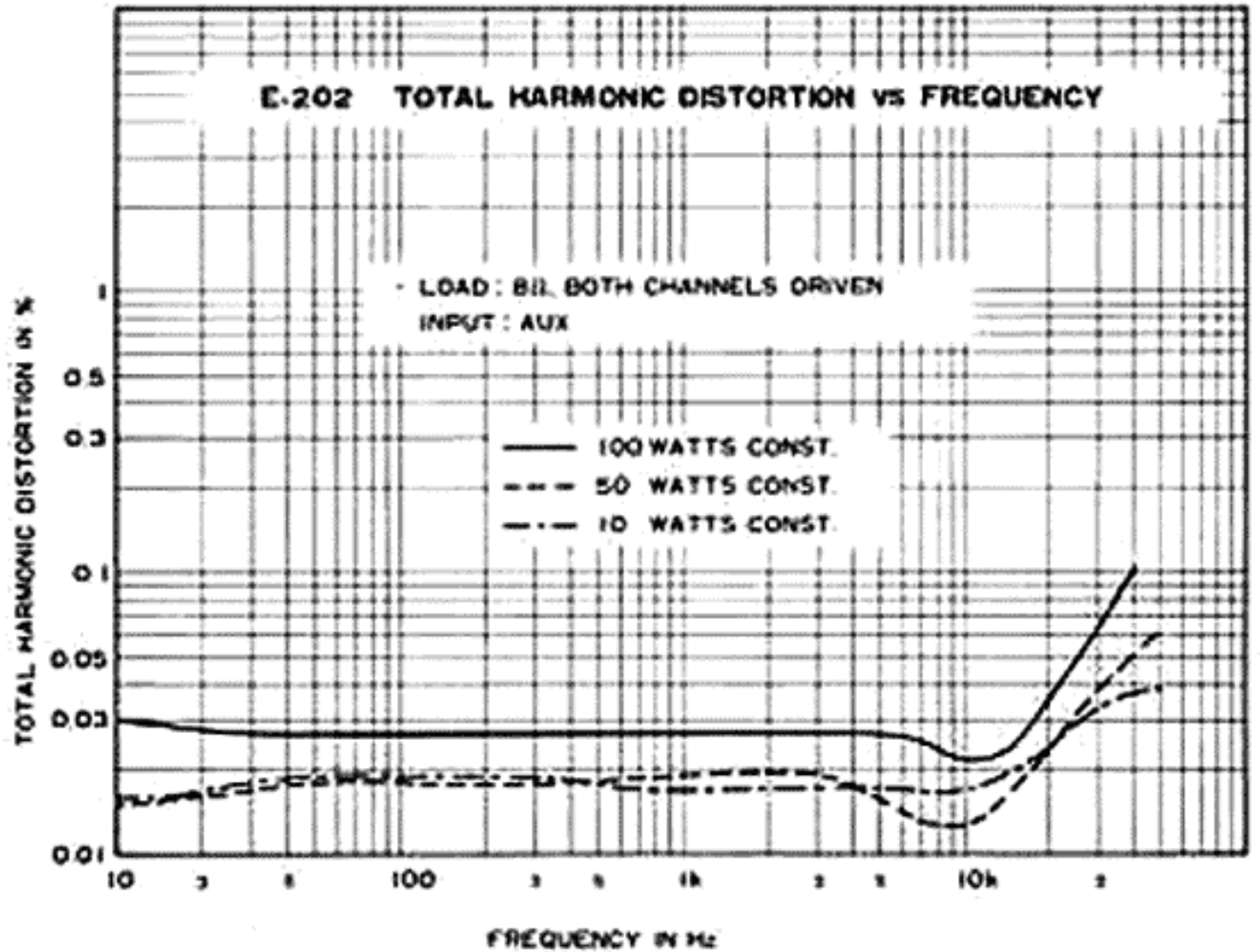
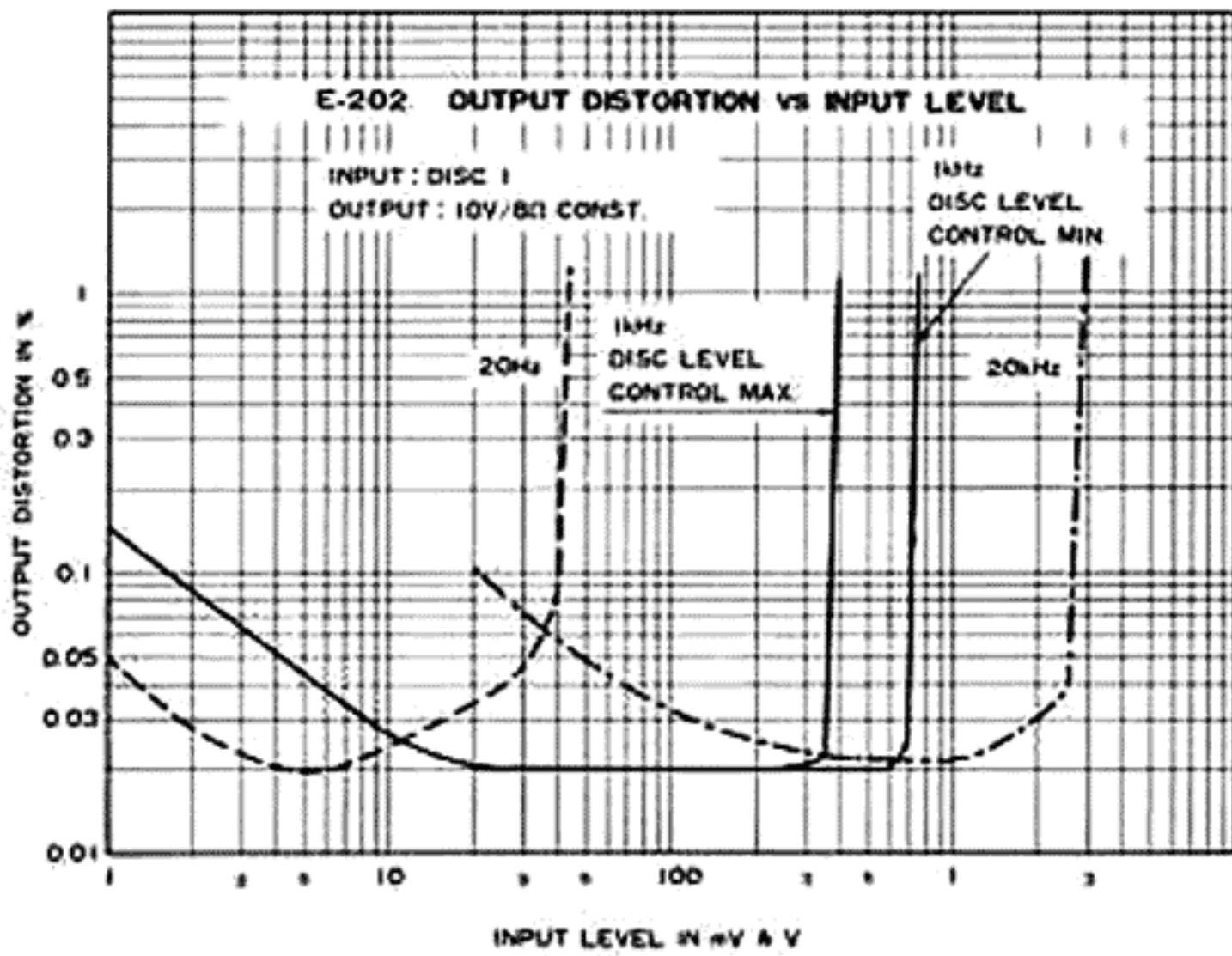
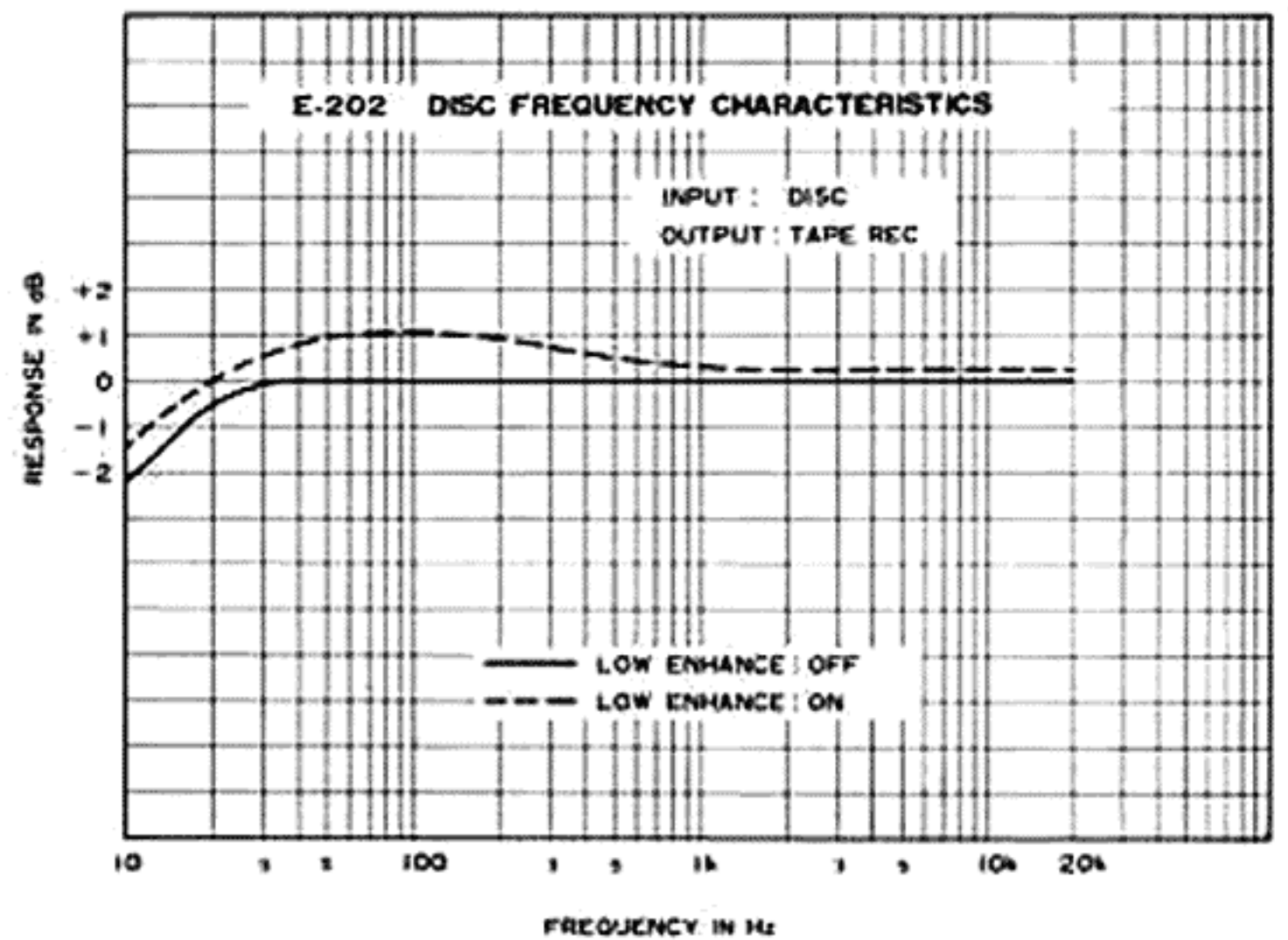
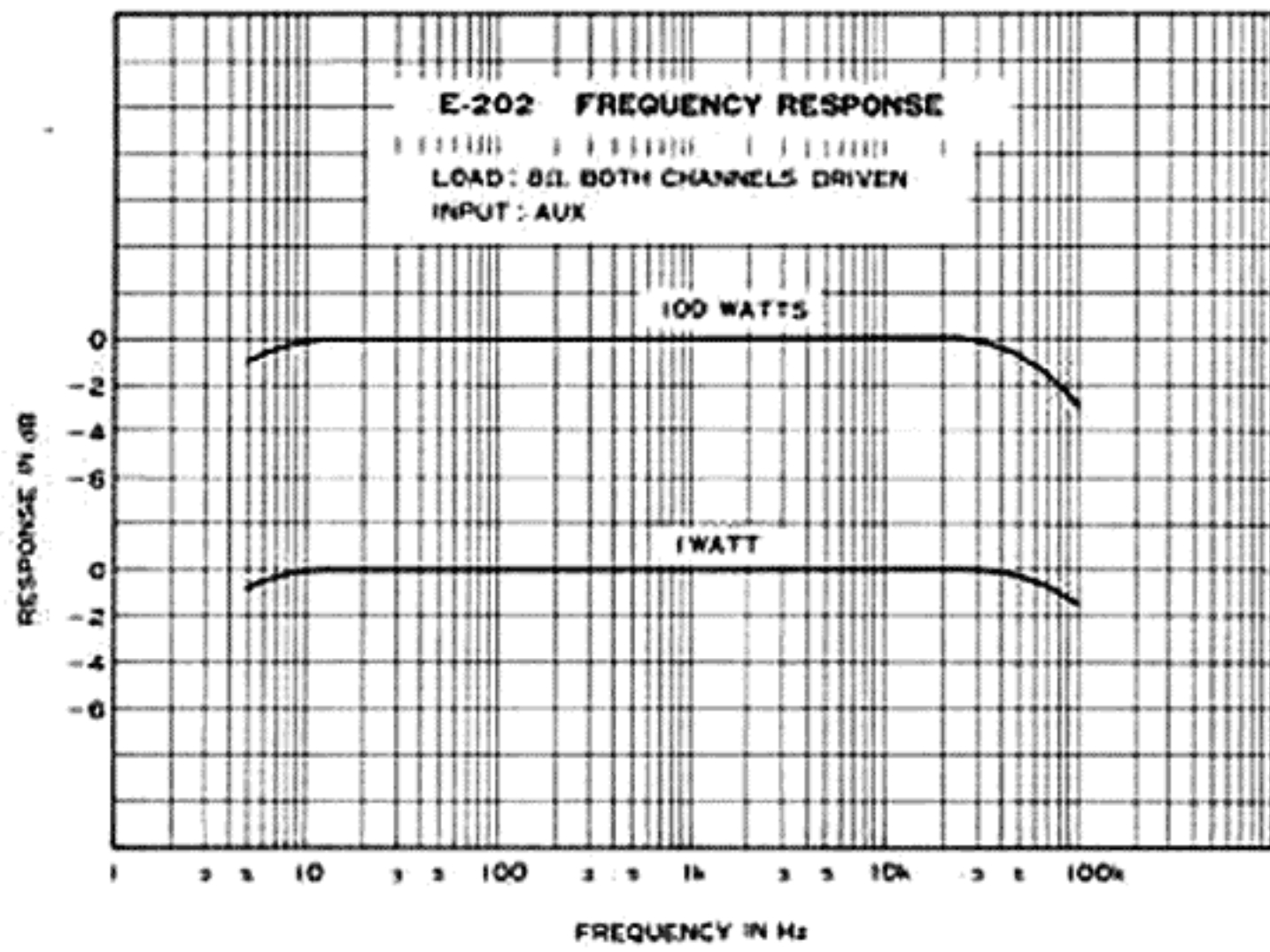



KENSONIC LABORATORY INC.

2124-6 MOTOISHIKAWA-CHO  
MIDORI-KU, YOKOHAMA 227 JAPAN  
Phone 045-912-2771